

# Clarke®



## RANDOM ORBITAL SANDER

MODEL NO: CROS3

PART NO: 6462012

### OPERATION & MAINTENANCE INSTRUCTIONS



LS0616

---

## INTRODUCTION

---

Thank you for purchasing this CLARKE Sander, which is designed for DIY and light workshop use only.

Read all safety warnings, instructions, illustrations and specifications provided with this power tool. In doing so you will ensure the safety of yourself and that of others around you, and you can look forward to your purchase giving you long and satisfactory service. Failure to follow all instructions listed may result in electric shock, fire and/or serious injury.

---

## GUARANTEE

---

This product is guaranteed against faulty manufacture for a period of 12 months from the date of purchase. Please keep your receipt which will be required as proof of purchase.

This guarantee is invalid if the product is found to have been abused or tampered with in any way, or not used for the purpose for which it was intended.

Faulty goods should be returned to their place of purchase, no product can be returned to us without prior permission.

This guarantee does not effect your statutory rights.

---

## SPECIFICATION

---

Electrical Supply	230V 50Hz 1 ph
Power rating	450 Watt
Fuse rating	5 Amp
No Load Speed (variable)	7000 - 14000 rpm
Net Weight	2.6 kg
Disc Size	125 mm
Vibration Emissions	4.596 m/s <sup>2</sup> / uncertainty value (k) =1.5 m/s <sup>2</sup>

---

# SAFETY PRECAUTIONS

---



**WARNING: READ ALL INSTRUCTIONS. FAILURE TO FOLLOW ALL INSTRUCTIONS LISTED BELOW MAY RESULT IN ELECTRIC SHOCK, FIRE AND/OR SERIOUS INJURY. THE TERM "POWER TOOL" IN ALL WARNINGS LISTED BELOW REFERS TO YOUR RANDOM ORBITAL SANDER.**

---

## 1) WORK AREA SAFETY

- a. **Keep work area clean and well lit.** *Cluttered or dark areas invite accidents.*
- b. **Do not operate power tools in explosive atmospheres, such as in the presence of flammable liquids, gases or dust.** *Power tools create sparks which may ignite the dust or fumes.*
- c. **Keep children and bystanders away while operating a power tool.** *Distractions can cause you to lose control.*

## 2) ELECTRICAL SAFETY

- a. **Power tool plugs must match the power outlet. Never modify the plug in any way. Do not use any adapter plugs with earthed (grounded) power tools.** *Unmodified plugs and matching power outlets will reduce risk of electric shock.*
- b. **Avoid body contact with earthed or grounded surfaces, such as pipes, radiators, ranges and refrigerators.** *There is an increased risk of electric shock if your body is earthed or grounded.*
- c. **Do not expose power tools to rain or wet conditions.** *Water entering a power tool will increase the risk of electric shock.*
- d. **Do not abuse the cable. Never use the cable for carrying, pulling or unplugging the power tool. Keep cable away from heat, oil, sharp edges or moving parts.** *Damaged or entangled cables increase the risk of electric shock.*
- e. **When operating a power tool outdoors, use an extension lead suitable for outdoor use.** *Use of a cable suitable for outdoor use reduces the risk of electric shock.*
- f. **If operating a power tool in a damp location is unavoidable, use a residual current device (RCD) protected supply.** *Use of an RCD reduces the risk of electric shock.*

## 3) PERSONAL SAFETY

- a. **Stay alert, watch what you are doing and use common sense when operating a power tool. Do not use a power tool while you are tired or under the influence of drugs, alcohol or medication.** *A moment of inattention while operating power tools may result in serious personal injury.*
- b. **Use personal protective equipment. Always wear eye protection.** *Protective equipment such as dust mask, non-skid safety shoes, hard hat, or hearing protection used for appropriate conditions will reduce personal injuries.*

- c. **Prevent unintentional starting. Ensure the trigger is in the off-position before connecting to power source, picking up or carrying the tool.** *Carrying power tools with your finger on the trigger or energising power tools that have the switch on invites accidents.*
- d. **Remove any adjusting key or wrench before turning the power tool on.** *A wrench or a key attached to a rotating part of the power tool may result in personal injury.*
- e. **Do not overreach. Keep proper footing and balance at all times.** *This enables better control of the power tool in unexpected situations.*
- f. **Dress properly. Do not wear loose clothing or jewellery. Keep your hair, clothing and gloves away from moving parts.** *Loose clothes, jewellery or long hair can be caught in moving parts.*
- g. **If devices are provided for the connection of dust extraction and collection facilities, ensure these are connected and properly used.** *Use of dust collection can reduce dust-related hazards.*

#### 4) POWER TOOL USE AND CARE

- a. **Do not force the power tool. Use the correct power tool for your application.** *The correct power tool will do the job better and safer at the rate for which it was designed.*
- b. **Do not use the power tool if the switch does not turn it on and off.** *Any power tool that cannot be controlled with the switch is dangerous and must be repaired.*
- c. **Disconnect the plug from the power source before making any adjustments, changing accessories, or storing power tools.** *Such preventive safety measures reduce the risk of starting the power tool accidentally.*
- d. **Store idle power tools out of the reach of children and do not allow persons unfamiliar with the power tool or these instructions to operate the power tool.** *Power tools are dangerous in the hands of untrained users.*
- e. **Maintain power tools. Check for misalignment or binding of moving parts, breakage of parts and any other condition that may affect the power tool's operation. If damaged, have the power tool repaired before use.** *Many accidents are caused by poorly maintained power tools.*
- f. **Keep cutting tools sharp and clean.** *Properly maintained cutting tools with sharp cutting edges are less likely to bind and are easier to control.*
- g. **Use the power tool, and accessories in accordance with these instructions, taking into account the working conditions and the work to be performed.** *Use of the power tool for operations different from those intended could result in a hazardous situation.*

#### 5) SERVICE

- a. **Have your power tool serviced by a qualified repair person using only identical replacement parts.** *This will ensure that the safety of the power tool is maintained.*

---

## SAFETY INSTRUCTIONS FOR KICKBACK

---









**WARNING: KICKBACK IS A SUDDEN REACTION TO A PINCHED OR SNAGGED ROTATING WHEEL, BACKING PAD, BRUSH OR ANY OTHER ACCESSORY. PINCHING OR SNAGGING CAUSES RAPID STALLING OF THE ROTATING ACCESSORY WHICH IN TURN CAUSES THE UNCONTROLLED POWER TOOL TO BE FORCED IN THE DIRECTION OPPOSITE OF THE ACCESSORY'S ROTATION AT THE POINT OF THE BINDING.**

**WARNING: KICKBACK IS THE RESULT OF POWER TOOL MISUSE AND/OR INCORRECT OPERATING PROCEDURES OR CONDITIONS AND CAN BE AVOIDED BY TAKING PROPER PRECAUTIONS AS GIVEN BELOW.**

---

1. Maintain a firm grip on the power tool and position your body and arm to allow you to resist kickback forces. Always use the auxiliary handle, if provided, for maximum control over kickback or torque reaction during start-up. The operator can control torque reactions or kickback forces, if proper precautions are taken.
2. Never place your hand near the sanding pad. It may kickback over your hand.
3. Do not position your body in the area where power tool will move if kickback occurs. Kickback will propel the tool in the direction opposite to the sanding pads movement at the point of snagging.
4. Use special care when working corners, sharp edges etc. Avoid bouncing and snagging the sanding pad. Corners, sharp edges or bouncing have a tendency to snag the rotating accessory and cause loss of control or kickback.

## SAFETY SYMBOLS

	Read instruction manual before use		Wear dust mask
	Class 2 Double Insulated		Wear ear defenders
	CE Mark		Wear safety glasses
	Weee Directive		

## DUST EXTRACTION

The sander is provided with a dust extraction facility. Please note however, that this does not preclude the user from wearing a face mask to prevent the inhalation of dust particles.

## ELECTRICAL CONNECTIONS



**WARNING: READ THESE ELECTRICAL SAFETY INSTRUCTIONS THOROUGHLY BEFORE CONNECTING THE PRODUCT TO THE MAINS SUPPLY.**

Before switching the product on, make sure that the voltage of your electricity supply is the same as that indicated on the rating plate. Connecting it to any other power source may cause damage.

If it is necessary to change the fuse in the plug, the fuse cover must be refitted. If the fuse cover becomes lost or damaged, the plug must not be used until a suitable replacement is obtained.

If the plug has to be changed due to damage, a replacement should be fitted, following the wiring instructions shown below. The old plug must be disposed of as insertion into a mains socket could cause an electrical hazard.



**WARNING: THE WIRES IN THE POWER CABLE OF THIS PRODUCT ARE COLOURED IN ACCORDANCE WITH THE FOLLOWING CODE:  
BLUE = NEUTRAL    BROWN = LIVE**

If the colours of the wires in the power cable of this product do not correspond with the markings on the terminals of your plug, proceed as follows.

- The wire which is coloured **Blue** must be connected to the terminal which is marked **N** or coloured **Black**.
- The wire which is coloured **Brown** must be connected to the terminal which is marked **L** or coloured **Red**.

**Plug must be BS1363/A approved.**

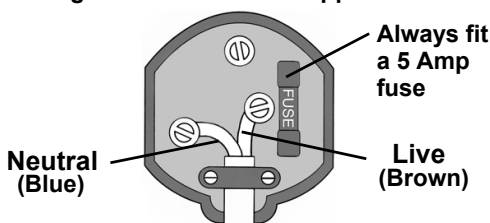

**Ensure that the outer sheath of the cable is firmly held by the clamp**

**We strongly recommend that this machine is connected to the mains supply via a Residual Current Device (RCD)**

If in any doubt, consult a qualified electrician. DO NOT attempt any repairs yourself.



**This symbol indicates that this is a Class II product, and does not require an earth connection.**

# PRODUCT OVERVIEW



NO	DESCRIPTION
1	Handle
2	Speed Control
3	Trigger
4	Sanding Pad

NO	DESCRIPTION
5	Auxiliary Handle
6	Lock-On Button
7	Dust Bag
8	2 x 60G sanding discs (not shown) 2 x 100G sanding discs (not shown) 1 x 150G sanding disc (not shown)



# PREPARATION AND USE

## FITTING A SANDING DISC

1. Select the disc to be used.
  - This MUST be the correct 125mm diameter disc with hook and loop backing.
2. Ensure the sander is switched off and the plug is removed from the socket.
3. Line up the holes in the disc with those on the sanding pad.
  - This is necessary for dust extraction purposes.
4. Press the disc firmly onto the pad to secure it.



## ADJUSTING THE AUXILIARY HANDLE

1. Loosen the handle adjustment knob.
2. Adjust the handle to the required position.
3. Retighten the handle adjustment knob.



## DUST COLLECTION

Slide the dust bag onto the outlet as shown.

The dust bag must be emptied regularly:- do not wait until it is completely full.

The dust bag is emptied as follows.

1. Ensure the sander is not running.
2. Gently remove the dust bag assy from the sander.
3. Take the dust bag to the dustbin and slip the bag off, (the bag has an elasticated top), empty the bag into the bin.
4. Reassemble the dust bag assy and fit back on to the sander.

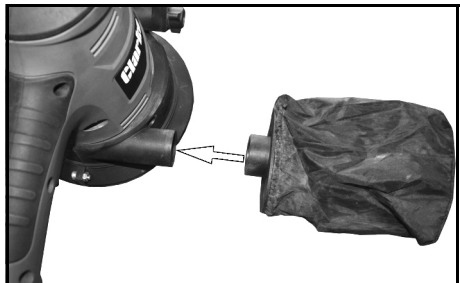

## OPERATION

1. Plug into the mains socket and switch on,
2. Place the sanding disc on the workpiece.
  - Hold the sander firmly with both hands.
3. Squeeze the trigger.
  - Work gently across the workpiece until smooth.
4. Release the trigger.
  - Wait until the motor has stopped fully before putting the sander down.

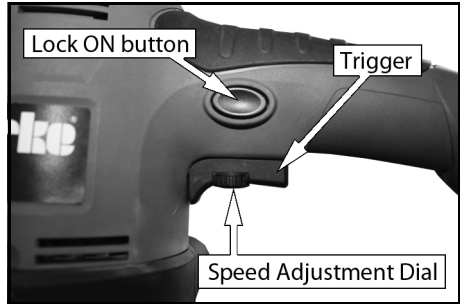

## SPEED CONTROL

To control the speed, turn the knob located on the trigger in the direction marked, i.e. - = lower speed + = higher speed.

## LOCK ON FEATURE

For continuous sanding:

1. Squeeze the trigger and then press the LOCK ON button.
  - The sander will continue to run even if the trigger is released.
2. To release the lock on feature, Squeeze the trigger again.

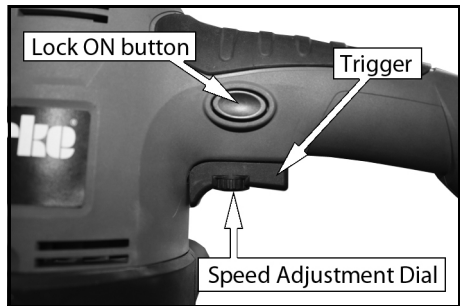

---

## MAINTENANCE

---

- Always inspect the sander before use and ensure it is in top condition.
- Ensure all air vents are clear. (Use vacuum cleaner to clean the machine where possible).
- Check the power cable to ensure it is sound and free from cracks, bare wires etc. Avoid using solvents when cleaning plastic parts, (most plastics are susceptible to damage from the various types of commercial solvents).
- All bearings etc., in this tool are lubricated with sufficient high grade lubricant for the machine's lifetime under normal operating conditions, therefore no further lubrication is required.

---

## REPLACEMENT DISCS

---

GRIT SIZE	PART NUMBER
60 grit (pack of 5)	6463051
100 grit (pack of 5)	6463052
150 grit (pack of 5)	6463053

---

## ENVIRONMENTAL RECYCLING POLICY

---



Through purchase of this product, the customer is taking on the obligation to deal with the WEEE in accordance with the WEEE regulations in relation to the treatment, recycling & recovery and environmentally sound disposal of the WEEE.

In effect, this means that this product must not be disposed of with general household waste. It must be disposed of according to the laws governing Waste Electrical and Electronic Equipment (WEEE) at a recognised disposal facility.

---

## TROUBLESHOOTING

---

PROBLEM	CAUSE	REMEDY
Sander is overheating.	The machine is blocked with dust.	Clean the ventilation holes. Wipe the exterior with a dry cloth.
Excessive Sparking.	Worn brushes.	This problem is easily remedied but you should consult your CLARKE dealer for parts and advice.
Sander does not operate when switched on.	Check to ensure the fuse in the plug is sound.	If the fuse is sound or blows repeatedly, consult your CLARKE dealer.
Dust is not extracted.	The dust bag is full or the dust extractor flue is blocked.	Remove and empty the bag, also clear any blockage.

# PARTS DIAGRAM

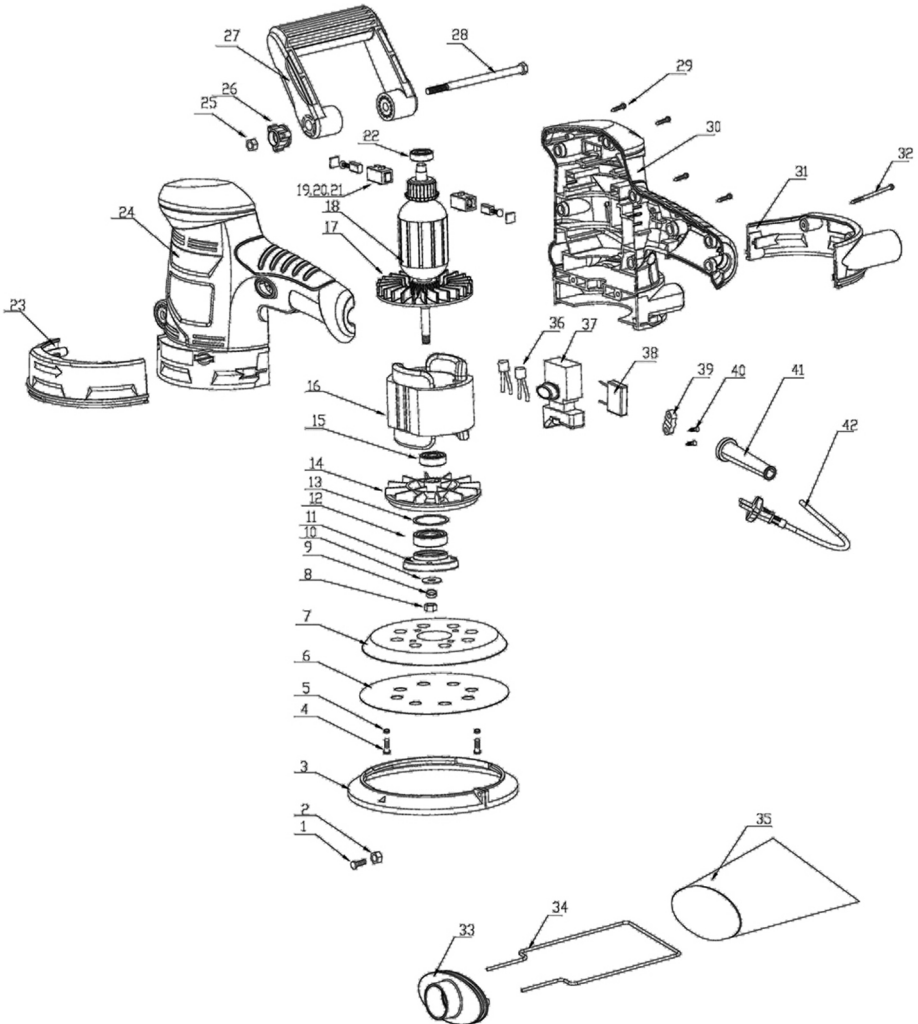

## PARTS LIST

ID	DESCRIPTION	ID	DESCRIPTION
01	Screw	22	Bearing
02	Nut	23	Partial Cover Of Left Housing
03	Dust Collection Circle	24	Left Housing
04	Self-tapping Screw	25	Nut
05	Spring Washer	26	Handle Adjument Knob
06	Sanding Paper	27	Adjustable Handle
07	Foam Sanding Pad	28	Hex Bolt
08	Nut	29	Self-tapping Screw
09	Spring Washer	30	Right Housing
10	Washer	31	Partial Cover Of Right Housing
11	Bearing Cover	32	Self Tapping Screw
12	Bearing	33	Dust Collection Sleeve
13	Lock Spring	34	Steel Frame Of Dust Collection Bag
14	Aluminum Fan	35	Dust Collection Bag
15	Bearing	36	Inductor
16	Stator	37	Switch
17	Fan	38	Capacitor
18	Rotor	39	Strain Relief
19	Carbon Brush Holder	40	Self-tapping Screw
20	Carbon Brush	41	Cable Sleeve
21	Carbon Brush Cover	42	Cable

**When requesting spare parts, please quote the reference WGCROS3 followed by the number listed.**

# DECLARATION OF CONFORMITY



**Clarke**<sup>®</sup>  
**INTERNATIONAL**

Hemnall Street, Epping, Essex CM16 4LG

## DECLARATION OF CONFORMITY

This is an important document and should be retained.

We hereby declare that this product(s) complies with the following directive(s):

2014/30/EU      *Electromagnetic Compatibility Directive.*

2006/42/EC      *Machinery Directive.*

2011/65/EU      *Restriction of Hazardous substances.*

The following standards have been applied to the product(s):

*EN 60745-1:2009+A11:2010, EN 60745-2-3:2011, EN 55014-1:2006 +A2:2011,*

*EN 55014-2:1997 +A2:2008, EN 61000-3-2:2014, EN 61000-3-3:2013.*

The technical documentation required to demonstrate that the product(s) meet(s) the requirement(s) of the aforementioned directive(s) has been compiled and is available for inspection by the relevant enforcement authorities.

The CE mark was first applied in: 2009

**Product Description:**            Orbital Sander  
**Model number(s):**            CROS3  
**Serial / batch Number:**        N/A  
**Date of Issue:**                14/06/2015

Signed:

J.A. Clarke  
Director

# A SELECTION FROM THE VAST RANGE OF

# Clarke®

## QUALITY PRODUCTS

### AIR COMPRESSORS

From DIY to industrial, Plus air tools, spray guns and accessories.

### GENERATORS

Prime duty or emergency standby for business, home and leisure.

### POWER WASHERS

Hot and cold, electric and engine driven - we have what you need

### WELDERS

Mig, Arc, Tig and Spot. From DIY to auto/industrial.

### METALWORKING

Drills, grinders and saws for DIY and professional use.

### WOODWORKING

Saws, sanders, lathes, mortisers and dust extraction.

### HYDRAULICS

Cranes, body repair kits, transmission jacks for all types of workshop use.

### WATER PUMPS

Submersible, electric and engine driven for DIY, agriculture and industry.

### POWERTOOLS

Angle grinders, cordless drill sets, saws and sanders.

### STARTERS/CHARGERS

All sizes for car and commercial use.



**PARTS & SERVICE: 0208 988 7400**

**E-mail: [Parts@clarkeinternational.com](mailto:Parts@clarkeinternational.com) or [Service@clarkeinternational.com](mailto:Service@clarkeinternational.com)**

**SALES: UK 01992 565333 or Export 00 44 (0)1992 565335**

**Clarke® INTERNATIONAL** Hemnall Street, Epping, Essex CM16 4LG  
[www.clarkeinternational.com](http://www.clarkeinternational.com)