

A SELECTION FROM THE VAST RANGE OF

**Clarke®**

**QUALITY PRODUCTS**

**AIR COMPRESSORS**

*From DIY to industrial. Plus air tools, spray guns and accessories.*

**GENERATORS**

*Prime duty or emergency standby for business, home and leisure.*

**POWER WASHERS**

*Hot and cold, electric and engine driven - we have what you need.*

**WELDERS**

*Mig, Arc, Tig and Spot. From DIY to auto/industrial.*

**METALWORKING**

*Drills, grinders and saws for DIY and professional use.*

**WOODWORKING**

*Saws, sanders, lathes, mortisers and dust extraction.*

**HYDRAULICS**

*Cranes, body repair kits, transmission jacks for all types of workshop use.*

**WATER PUMPS**

*Submersible, electric and engine driven for DIY, agriculture and industry.*

**POWER TOOLS**

*Angle grinders, cordless drill sets, saws and sanders.*

**STARTER/CHARGERS**

*All sizes for car & commercial use.*



**Clarke®**  
**WOODWORKER**

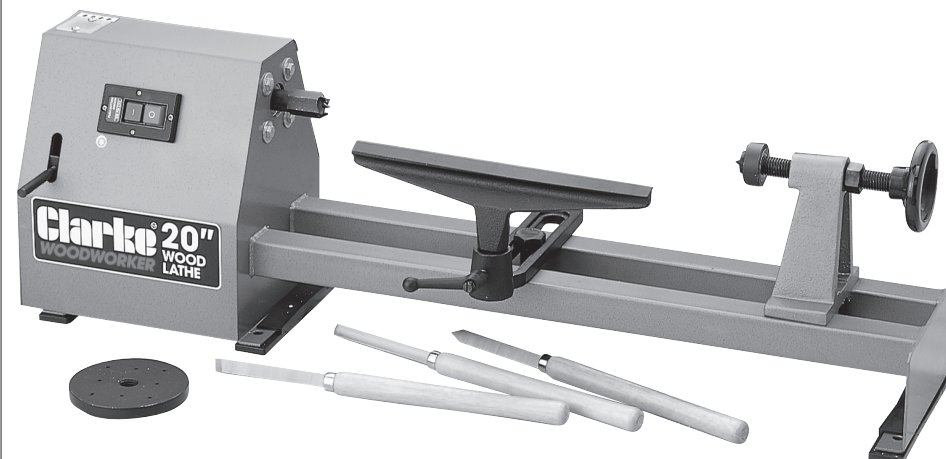

**20" WOODLATHE**

**Model No. CWL6B**

Part No. 6501650

OPERATING & MAINTENANCE

INSTRUCTIONS

**Clarke INTERNATIONAL**

For spare parts and servicing, please contact your nearest dealer, or Clarke International on

**020 - 8988 - 7400**

e-mail: [Parts@clarkeinternational.com](mailto:Parts@clarkeinternational.com) e-mail: [Service@clarkeinternational.com](mailto:Service@clarkeinternational.com)

**Hemnall Street, Epping, Essex CM16 4LG**



## CONTENTS

Page

Lathe Specifications .....	3
General Safety Instructions .....	4
Wood Lathe Safety Instructions .....	5
Electrical Connections and Motor Specifications .....	6
Unpacking And Checking Contents .....	7
Spindle Speeds and Belt Tensioning .....	8
Preparation for use (Spindle/Faceplate/Outboard Turning & Indexing) .....	9
Using Woodworking Chisels and Basic Techniques .....	12
Making Standard Cuts .....	17
Spindle Turnings .....	20
Face Plate And Chuck Turnings .....	22
Fancy Face Plate Turnings .....	23
Turning Plastics .....	26
Sanding, Buffing And Polishing .....	27
Maintenance .....	28
Lubrication .....	28
Optional Accessories .....	29
Spares And Servicing Contacts .....	29
Parts List .....	30
Parts Diagram .....	31

## PARTS DIAGRAM

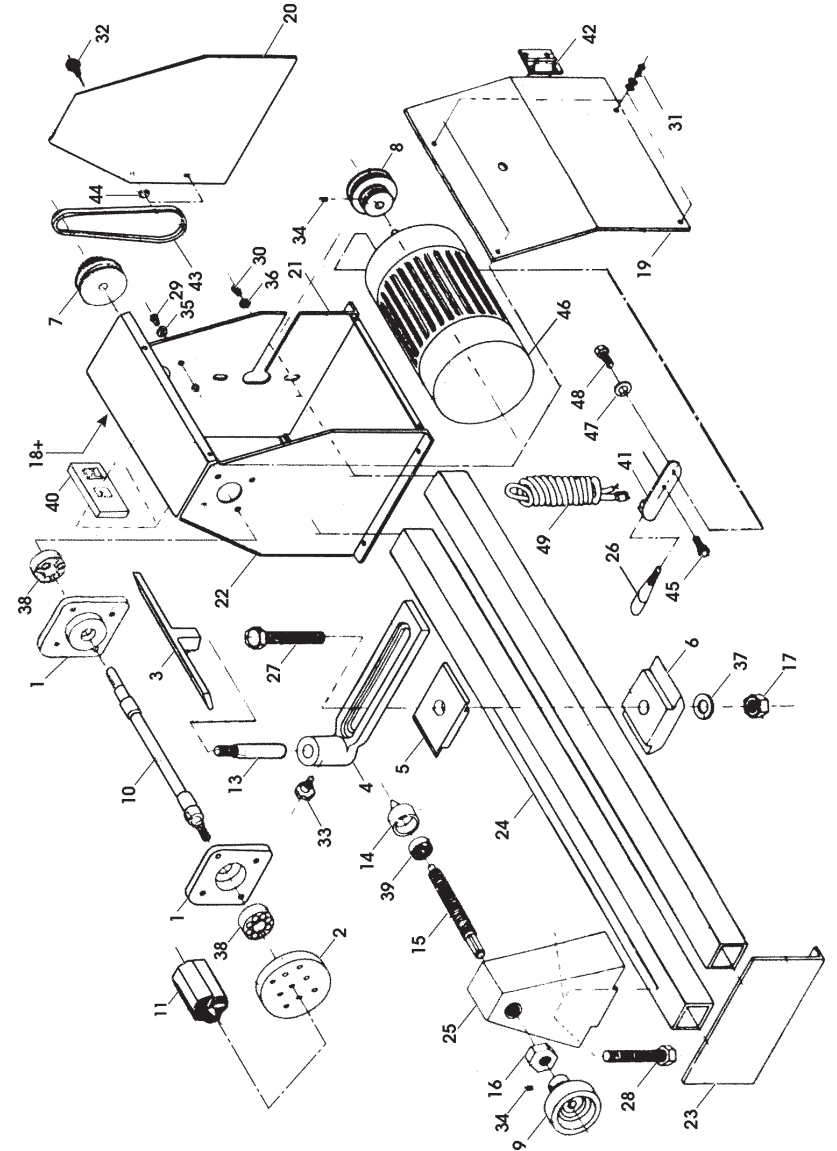

## PARTS LIST

No.	Description	Part No.	No.	Description	Part No.
1	Bearing Block	SD6001	26	Belt Tension Lever	SD6026
2	Face Plate	SD6002	27	Bolt	SD6027
3	Tool Rest	SD6003	28	Bolt	SD6028
4	Tool Rest Holder	SD6004	29	Bolt	SD6029
5	Slide Block	SD6005	30	Bolt	SD6030
6	Locking Block	SD6006	31	Machine Screw	SD60231
7	Spindle Pulley	SD6007	32	Bolt	SD6032
8	Motor Pulley	SD6008	33	Lock Knob	SD6033
9	Hand Wheel	SD6009	34	Socket Head Screw	SD6034
10	Head Stock Spindle	SD6010	35	Washer	SD6035
11	Driving Centre	SD6011	36	Washer	SD6036
12	Name Plate (Not Shown)	SD6012	37	Washer	SD6037
14	Tool Rest Shaft	SD6014	38	Bearing	SD6038
15	Tailstock Spindle	SD6015	39	Bearing	SD6039
16	Locknut	SD6016	40	Switch	SD6040
17	Locknut	SD6017	41	Belt Tensioning Lever	SD6041
18	Headstock Cover - 1	SD6018	42	Hinge	SD6042
19	Motor Cover	SD6019	43	Belt	SD6043
20	Pulley Cover	SD6020	45	Bolt	SD6045
21	Headstock Cover - 2	SD6021	46	Motor	SD6046
22	Headstock Cover - 3	SD6022	47	Washer	SD6047
23	Mounting Foot	SD6023	48	Bolt	
24	Bed Rail	SD6024	49	Power Cable with Plug	
25	Tailstock	SD6025			

**Clarke**<sup>™</sup>  
INTERNATIONAL

Thank you for purchasing this CLARKE 20" Wood lathe, designed for DIY use only.

Before assembling this machine, please read this manual thoroughly and follow all instructions carefully. In doing so you will ensure the safety of yourself and that of others around you, and you can look forward to the wood lathe giving you long and satisfactory service.

## GUARANTEE

This CLARKE product is guaranteed against faulty manufacture for a period of 12 months from the date of purchase. Please keep your receipt as it will be required as proof of purchase. This guarantee is invalid if the product is found to have been abused or tampered with in any way, or not used for the purpose for which it was intended.

Faulty goods should be returned to their place of purchase, no product can be returned to us without prior permission. This guarantee does not effect your statutory rights.

### WARNING:

**THIS MACHINE MUST NOT BE MODIFIED, OR USED FOR ANY PURPOSE OTHER THAN THAT FOR WHICH IT IS DESIGNED.**

## SPECIFICATIONS

Motor .....	230V 50Hz 1Ph
Power Rating .....	370W (1/2 HP)
Switch Type .....	No Volt Release
Turning Capacity (Between Centres) .....	20 in (508mm)
(Over Bed) .....	9 1/2in Dia (242mm)
Spindle Speeds	1. .... 850RPM
	2. .... 1250RPM
	3. .... 1750RPM
	4. .... 2510RPM
Headstock Thread .....	3/4" x 16TPI (UNF)
Tailstock Spindle .....	Fixed Rotating Centre
Tailstock Spindle Advance .....	2" (50mm) max. via hand wheel
Overall Dimensions (LxWxH) .....	950x220x280mm
Weight .....	24kg

## GENERAL SAFETY RULES FOR OPERATING MACHINERY

### WARNING

*As with all machinery, there are certain hazards involved with their operation and use. Exercising respect and caution will considerably lessen the risk of personal injury. However, if normal safety precautions are overlooked, or ignored, personal injury to the operator may result.*

1. **KNOW YOUR MACHINE.**  
Read the manual carefully. Learn the machines applications and limitations, as well as the specific potential hazards peculiar to it.
2. **KEEP GUARDS IN PLACE**  
and in working order.
3. **EARTH ALL MACHINES.**  
If the machine is equipped with three-pin plug, it should be plugged into a three-pin electrical socket. Never remove the earth pin.
4. **REMOVE ADJUSTING KEYS AND WRENCHES.**
5. **KEEP WORK AREA CLEAN.**  
Cluttered areas and benches invite accidents.
6. **DON'T USE IN DANGEROUS ENVIRONMENT.**  
Don't use machinery in damp or wet locations, or expose them to rain. Keep work area well lit.
7. **KEEP CHILDREN AND VISITORS AWAY.**  
All children and visitors should be kept a safe distance from work area.
8. **MAKE WORKSHOP CHILDPROOF**  
Use padlocks, master switches or remove starter keys etc.
9. **DON'T FORCE THE MACHINE.**  
It will do the job better and safer, at the rate for which it was designed.
10. **USE RIGHT TOOL.**  
Don't force a tool or attachment to do a job for which it was not designed.
11. **WEAR PROPER APPAREL.**  
Loose clothing, gloves, neckties, rings, bracelets, or other jewellery may get caught in moving parts. Nonslip footwear is recommended. Long hair should be contained.
12. **USE SAFETY GLASSES.**  
Also use face or dust mask if cutting operation is dusty. Everyday eyeglasses only have impact resistant lenses, they are NOT safety glasses.
13. **USE EAR DEFENDERS.**
14. **DON'T OVERREACH.**  
Keep proper footing and balance at all times.
15. **MAINTAIN TOOLS IN TOP CONDITION.**  
Keep tools sharp and clean for best and safest performance. Follow instructions for lubricating and changing accessories.
16. **ALWAYS DISCONNECT THE MACHINE**  
before servicing or changing accessories.
17. **AVOID ACCIDENTAL STARTING.**  
Ensure the machine is switched OFF before plugging in.
18. **CHECK FOR DAMAGE.**  
If part of the machine (eg. A cover or guard), is damaged, it should be carefully inspected to ensure that it can perform its' intended function correctly. If in doubt, the part should be renewed. Damage to moving parts or major components should be inspected by a qualified technician before operating the machine. Contact your local dealer for advice.
19. **DO NOT STAND ON THE MACHINE.**  
Serious injury could occur if the machine is tipped over. Do not store materials above or near the machine such that it is necessary to stand on the machine to get to them.
20. **NEVER operate a machine when under the influence of alcohol, drugs or medication.**

## OPTIONAL ACCESSORIES

A full range of optional accessories (detailed below) are available from your local dealer.

<u>Accessory</u>	<u>Part No</u>
Cup Turning Chuck	6500641
Screw Chuck	6500642
4 Jaw Independent Lathe Chuck	6500645
6" Face Plat (Right Hand)	6500646
8 Piece Chisel Set	6500649

## SPARE PARTS AND SERVICING

For spare parts or servicing, please contact your nearest Clarke dealer or Clarke International on one of the following numbers.

**PARTS & SERVICE TEL: 020 8988 7400**

**or e-mail as follows:**

**PARTS: [Parts@clarkeinternational.com](mailto:Parts@clarkeinternational.com)**

**SERVICE: [Service@clarkeinternational.com](mailto:Service@clarkeinternational.com)**

**Clarke**<sup>™</sup>  
INTERNATIONAL



glued or tacked in place, do satisfactory work. These have the advantage that special sizes, tapers etc., can be made.

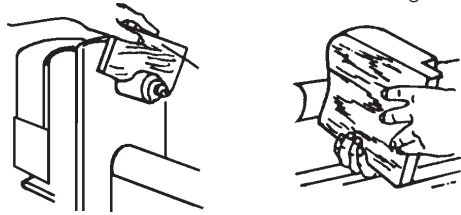

Fig. 59

The drum is used mainly for sanding the edges of curved work. The squareness of the edge of the work can be best retained by using a simple form of vertical fence as shown. The standard sanding drums are commonly made with a threaded hole to fit the Lathe Drive Spindle. To guard against loosening of the taper shank while the drum is in operation, it is advisable to support the free end, using either a ball bearing or plain 60° centre in the tailstock.

#### 4. USE OF WOOD CHUCKS FOR SANDING

Quick acting chucks can be very useful for sanding operations on duplicate production parts. The chuck is made slightly oversized, and a piece of rubber hose (for small parts) is inserted in the recess to grip the workpieces. Workpieces can be changed without stopping the lathe.

Fig. 60

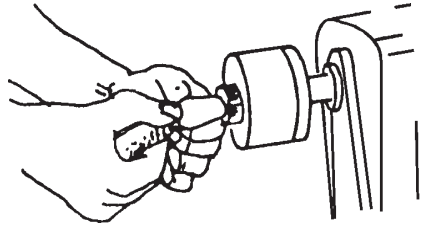

## MAINTENANCE

### WARNING :

*For your own safety, turn the switch 'off' and remove the plug from the electrical socket before maintaining or lubricating your lathe.*

Frequently blow out any dust that may accumulate inside the motor.

If the mains lead is worn, cut or damaged in any way, have it replaced immediately.

## LUBRICATION

All the BALL BEARINGS are packed with grease at the factory and require no further lubrication.

Periodically lubricate the the tailstock screw threads with either SAE20 or SAE30 engine oil.

## ADDITIONAL SAFETY RULES FOR WOOD LATHES

1. **IMPORTANT:** You should not operate this machine unless you are thoroughly familiar with wood turning lathes and wood turning techniques. If there is any doubt whatsoever, you should consult a qualified person.
2. Do not operate the machine until it is completely assembled, and this entire manual, has been read and understood.
3. Ensure the proper electrical regulations are followed. The machine must be properly earthed.
4. Before switching the machine ON, **ALWAYS:-**
  - a. Clear the lathe bed of ALL objects (tools, scraps of wood etc.).
  - b. Examine the setup carefully, ensuring nothing could possibly interfere with the rotating workpiece. eg. The tool rest is secure and not liable to swing into the workpiece. Rotate workpiece by hand to check.
  - c. Ensure the tool rest is adjusted to the correct height, and is as close to the workpiece as possible.
  - d. Ensure all clamps are properly secured.
  - e. Ensure your clothing is properly adjusted.
  - f. Ensure the workpiece is centralised.
5. Make all adjustments with the power OFF.
6. **ALWAYS** use the slowest speed when starting a new workpiece, and cut at correct speed for material and shape.
7. **ALWAYS** remove the tool rest when sanding or polishing.
8. When turning between centres, always ensure that the tailstock centre is snug against the workpiece, with the spindle locked, AND the Tailstock securely locked to the bed. NEVER loosen the tailstock spindle OR the tailstock with the workpiece turning.  
NOTE: The centre should be lubricated (unless it is a ball bearing type).
9. **DO NOT** drive the workpiece into the centre when the centre is installed in the headstock. Always set the workpiece into the centre with a soft mallet first, and then mount the Centre with workpiece attached into headstock spindle.
10. When using the Faceplate, ensure the workpiece is securely fastened to it and the appropriate size faceplate is used to correctly support the workpiece. Ensure the securing screws cannot interfere with the turning tool at the finished dimension.
11. **ALWAYS** rough cut the workpiece as close as possible to the finished shape before mounting on to a faceplate.
12. **ALWAYS** examine the workpiece for flaws. Do not use wood which is split or has knots. Test glued joints before mounting on to lathe to ensure they have completely set.
13. When roughing off, **DO NOT** jam tool into workpiece or take too big a cut.
14. **NEVER** attempt to remount a faceplate turning to the faceplate for any reason. Never attempt to remount a between-centres turning if the original centres in the turning have been altered or removed.
15. **ALWAYS** clean the machine at the end of a working session. Remove centres from the headstock AND tailstock and store them. Ensure the work area is cleaned before leaving the machine.
16. Should any part of the lathe be missing, damaged, or fail in any way, or any electrical component fail to perform properly, shut OFF the machine and disconnect from the power supply. Replace missing, damaged or failed parts before resuming operation. If in doubt, consult your local dealer. Always disconnect from power supply when carrying our repairs.
17. Be particularly careful with your clothing when operating a lathe. Always wear safety glasses. Long hair should be contained. See General Safety Instructions - Apparel.
18. Do not exceed recommended speeds. Refer to chart on page 12.

## ELECTRICAL CONNECTIONS

Connect the mains lead to a standard 230 volt (50Hz) electrical supply using a 13 amp BS1363 plug fitted with a 13 amp fuse, or a suitably fused isolator switch.

**WARNING : THIS APPLIANCE MUST BE EARTHED.**

IMPORTANT : The wires in the mains lead are coloured in accordance with the following code :

Green & Yellow	-	Earth
Blue	-	Neutral
Brown	-	Live

As the colours of the flexible cord of this appliance may not correspond with the coloured markings identifying terminals in your plug, proceed as follows :-

Connect GREEN & YELLOW coloured cord to plug terminal marked with a letter "E" or Earth symbol  or coloured GREEN or GREEN & YELLOW.

Connect BROWN coloured cord to plug terminal marked letter "L" or coloured RED.

Connect BLUE coloured cord to plug terminal marked letter "N" or coloured BLACK.

We recommend that this unit is fitted with a Residual Current Device (RCD)

If this appliance is fitted with a plug which is moulded onto the electric cable (i.e. non-rewirable) please note:

1. The plug must be thrown away if it is cut from the electric cable. There is a danger of electric shock if it is subsequently inserted into a socket outlet.
2. Never use the plug without the fuse cover fitted.
3. Should you wish to replace a detachable fuse carrier, ensure that the correct replacement is used (as indicated by marking or colour code).
4. Replacement fuse covers can be obtained from your local dealer or most electrical stockists.
5. The fuse in the plug must be replaced with one of the same rating (13 amps) and this replacement must be ASTA approved to BS1362.

We recommend that this machine is connected to the mains supply through a Residual Current Device (RCD).

**If in doubt, consult a qualified electrician. Do not attempt any electrical repairs yourself.**

### FUSE RATING

The fuse in the plug for this appliance must be rated at **13 amps**

## MOTOR SPECIFICATIONS

The four speed pulley system of this lathe is designed to use a 1725 RPM, 370W motor. Rotation is clockwise as viewed from the pulley end of the shaft. It is wired for 230 Volt, 50Hz.

**Caution: Do not any other type of motor as their use may be hazardous.**

The machines' ON and OFF buttons are marked "I" for ON and "O" for OFF.

Should the power fail whilst the machine is in use, the NO VOLT RELAY will operate. This is a safety feature which prevents the machine from starting up automatically when the power is restored. It will be necessary to press the ON button to continue operations.

## SANDING, BUFFING AND POLISHING

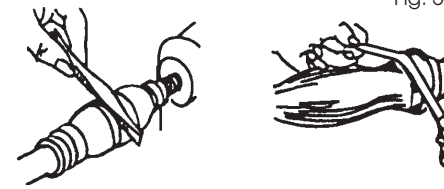

Fig. 56

### 1. USING THE LATHE TO SAND TURNINGS

Turnings should be sanded with the lathe running in second lowest speed. A large sheet of sandpaper is useful for smoothing cylinders. All other sanding operations are done with a narrow strip of abrasive paper. The best finishing grit is 3/0 for soft wood, 4/0 for hard woods. Worn 2/0 paper is often used, and is the equivalent of 3/0 or 4/0 new paper.

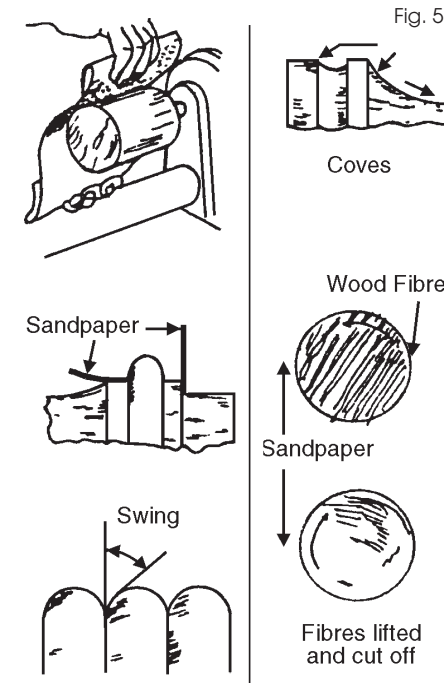

Fig. 57

The application of the sandpaper strip is shown in fig. 57. Care must be exercised in order to prevent dubbing the corners of beads, shoulders etc. It is good practice to finish sanding with the work in reverse rotation. This is particularly true when sanding basswood, white pine and mahogany. These woods are hard to sand clean since sanding packs the surface fuzz down to the wood. Sanding very lightly, and not too long with the lathe reversed, will lift the fibres and cut them off cleanly.

### 2. USE OF SANDING DISCS

A fully adjustable sanding table adds to the scope and convenience of sanding operations. Sanding is always done on the down travel side of the wheel working on the other side would kick the work upwards. Either second or third speed can be used.

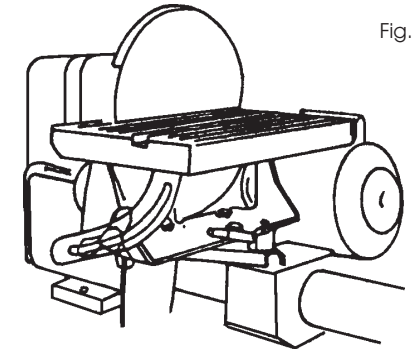

Fig. 58

The sanding disc is a metal plate with a threaded shank which fits the end of the lathe spindle. Abrasive paper is glued to the machined surface of the plate by means of a quick drying cement supplied for this purpose. Abrasive discs can be purchased or cut from the standard sizes of abrasive paper.

### 3. USE OF SANDING DRUMS

Standard sanding drums are usually rubber cylinders which can be expanded to hold an abrasive sleeve in place. Similar cylinders turned on the lathe and covered with abrasive paper

## TURNING PLASTICS

### 1. TYPES OF PLASTICS

There are two general groups of plastics. The first includes all phenol plastics moulded under heat and pressure. Bakelite and Formica are examples. In the second are all catalyst setting plastics of various bases sold under such trade names as Lucite, Catalin, Cast Bakelite, Marblette, Tenite and Trafford. Those in the second group are most generally used for craftwork. They are easy to turn, being a little harder than wood but much softer than any of the soft metals.

### 2. MOUNTING THE WORK

The most useful mounting device is the 4-jaw (metal lathe) chuck. When this is not available, cylinders can be mounted on a slightly tapered wooden mandrel. Rods can be mounted between centres, using either the wood mounting centres or metal mounting arrangements. When the spur centre is used, slots should be sawed across the work.

### 3. USE OF WOOD TURNING CHISELS

Fig. 53

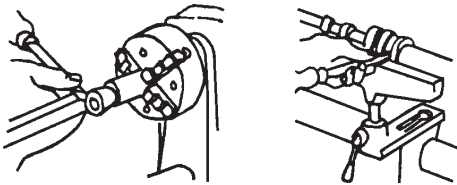

Standard wood turning chisels are excellent for turning plastics by means of scraping methods. The tool rest should be slightly below centre and the chisel handle should be held a little higher than the cutting edge to give a negative rake. Scraping tools should be kept to a minimum. A large contact area, such as the full edge of the spear-point chisel, will cause chatter and probable chipping.

Properly worked, the chip comes off in a continuous ribbon. In cold weather, plastic may become brittle and should be tempered in warm water for about ten minutes before turning.

### 4. USE OF FORMED TOOLS FOR PRODUCTION BEADING AND SIMILAR OPERATIONS

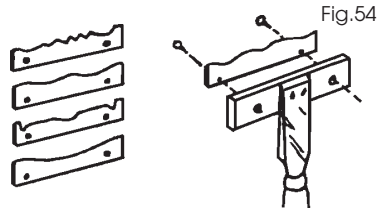
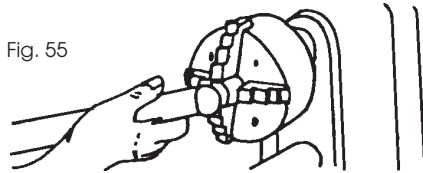

Fig. 54

When a number of identical pieces are to be produced, all having a distinctive surface pattern, preformed tools will speed the work and assure uniformity. Patterns like those illustrated can be created by grinding thin gauge aluminium strips. A holder, like the one shown, can then be used to support any one of your prepared strips and guide it against the workpiece.

### 5. TURNING BALLS

Fig. 55



Plastic balls are rough turned in the usual manner and then brought to perfect roundness by using a tube tool. The tube should be slightly less in diameter than the finished size of the ball. It can be brass or steel, ground square across the end. The tool is used with or without a rest, and is worked by swinging it from side to side.

### 6. POLISHING PLASTICS

Start with sanding. First use 150-grit dry paper to remove tool marks, then finish off with 400-grit papers, in succession, used wet. Press lightly to avoid overheating and marring the work. Buffing gives the final polish, using the polishing compounds commonly supplied for this purpose. Do not press too hard or hold wheel at one spot too long, keep moving around, otherwise the plastic might become heat marked.

## UNPACKING AND CHECKING CONTENTS OF CARTON

Your wood lathe is shipped complete in one carton and is fully assembled at the factory, with the exception of the Belt Tensioning Lever. Screw this into the socket to the left of, and directly below, the ON/OFF switches.

If any parts are missing or damaged in any way, please contact your Clarke dealer immediately.

Ensure the lathe is secured firmly to a firm level surface...a sturdy workbench for example, or, if necessary, a piece of 1/2" ply may be used, and this in turn should be clamped to a strong work surface when the lathe is in use. The lathe may then be moved to a more convenient location for storage purposes. This is handy if workspace is limited.

If a piece of ply is used, ensure the mounting screws are countersunk into the underside of the ply, so that the bearing surface is completely flat.

## MAIN COMPONENTS

Fig. 1

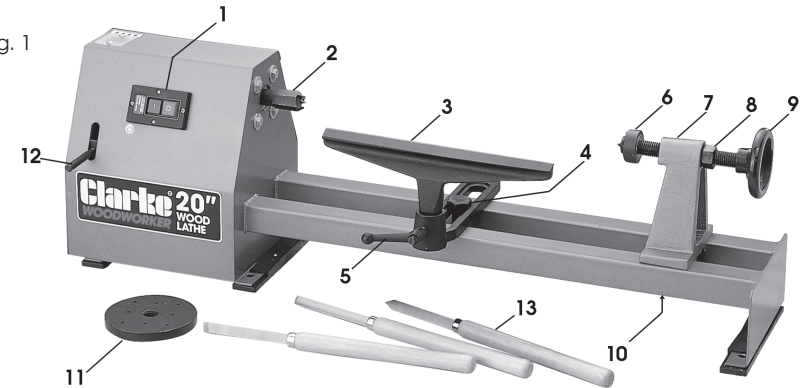

- |                            |                               |
|----------------------------|-------------------------------|
| 1. ON/OFF switches         | 8. Tailstock Spindle Locknut  |
| 2. Drive Centre            | 9. Tailstock Advancing Handle |
| 3. Tool Rest               | 10. Tailstock Locknut         |
| 4. Tool Rest Holder        | 11. Face Plate                |
| 5. Tool Rest Locking Lever | 12. Belt Tensioning Lever     |
| 6. Tailstock Spindle       | 13. 3-Piece Chisel Set        |
| 7. Tailstock               |                               |

## ACCESSORIES

Fig. 2

- |                                  |
|----------------------------------|
| 1. 4-Jaw Independent Lathe Chuck |
| 2. Cup Turning Chuck             |
| 3. Screw Chuck                   |
| 4. Face Plate Right Hand         |

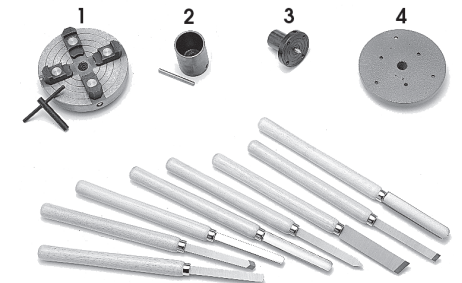

## SPINDLE SPEEDS

A chart showing spindle speeds and recommended turning speeds is mounted on the Head cow and for convenience, is duplicated as follows:

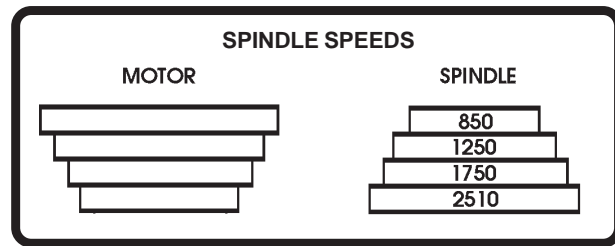

### RECOMMENDED GENERAL SPEEDS

#### SPINDLE TURNING

SQUARE	LENGTH
1" (25mm)	12" (305mm)
2" (50mm)	16" (406mm)
3" (75mm)	20" (508mm)
4" (100mm)	20" (508mm)

ROUGHING	FINISHING
1750	2510
1250	2510
850	2510
850	2510

#### FACE PLATE TURNING

DIAMETER	THICKNESS
9" (228mm)	4" (100mm)Max.
8" (205mm)	4" (100mm)Max.
6" (150mm)	4" (100mm)Max.

ROUGHING	FINISHING
850	2510
1250	2510
1750	2510

**CAUTION : MAKE SURE THE POWER CORD IS REMOVED FROM THE OUTLET BEFORE ATTEMPTING TO CHANGE THE BELT POSITION.**

### Changing speeds

1. Undo the two screws securing the Pulley Access Panel.
2. Slacken the two Motor securing bolts - arrowed in Fig. 3.
3. Pull down on the Belt Tension Lever to remove belt tension.
4. Move belt to appropriate pulley.
5. Pull up on Belt Tension Lever to tension belt. It should be firm - 1/2" total movement at the middle of the run.
6. Retighten Motor securing bolts and replace Pulley Access Cover.

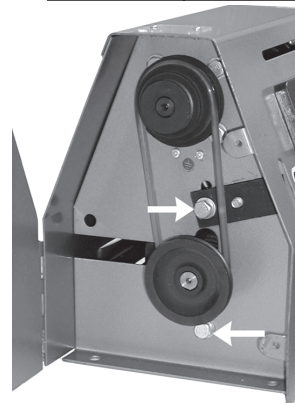
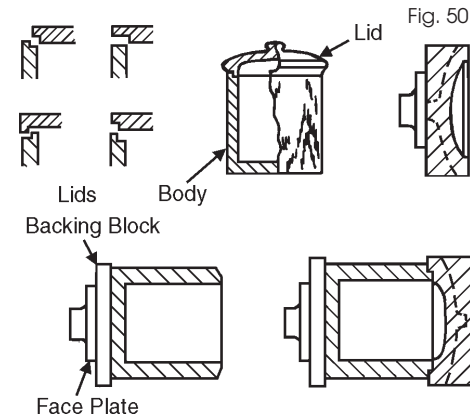

Fig.3 shows the belt positioned on the second step from the outside edge of the pulley. This produces a spindle speed of 1250 RPM. (Refer to the chart above).

If you wish to run at a higher speed, say 2510 RPM, you must shift the belt inwards, 2 steps.

the ball is constantly shifted, never more than 1/8 turn and always with a definite pattern. Since turning between centres makes the work a perfect sphere across the grain, the ball must be mounted in the chuck so that the first scraping cuts will round it up in the opposite direction .

## 6. TURNED BOXES



Turned boxes involve deep recessing together with a special system of working the lid and body of the box together as one unit. The inside of the lid is turned first. Next, the inside of the body is turned. A careful check must be made when turning the body portion so that the lid will be a tight press fit. The lid is then pressed on to the body and the outer circumference and face of the lid, together with the outer circumference of the body, are turned all at one time. This insures accurate matching of the two pieces. After the work is complete, the tight fit of the lid can be relieved by sanding the lip of the body.

## 7. SEGMENTED TURNINGS

Segmented turnings and boxes can be extremely attractive and this method of preparing wood stock is more economical than the use of a large stock piece.

For some types of work, segmenting is the only practical method because a block (if obtainable), would be so large that it would be very likely to warp.

The bowl illustrated in fig. 51 requires 12 segment pieces for the sides. Bowls can be worked with 6 or 8 pieces if desired.

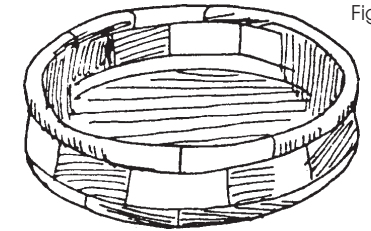

Fig. 51

To make the 12-piece bowl, a board about 22x76x760mm, is cut into pieces about 65mm long, the saw blade being tilted 15° and the board being turned alternatively face up and face down to make the successive cuts. These 12 pieces glued together and clamped by wrapping the assembly with wire. When dry the rim thus formed is glued to a temporary circular backing which is mounted on the large faceplate.

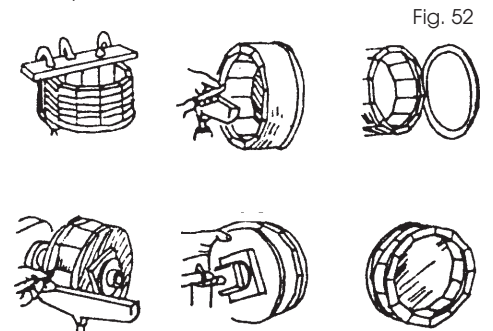

Fig. 52

A recess of the largest possible diameter, and about 22mm deep, is turned in the open end of the rim. The rim is removed from the lathe, and stock for the bottom is mounted in its place on a second faceplate. This is turned to size and a rim about 3mm deep is turned to exactly fit the recess prepared in the rim. The rim is then fitted over the bottom and glued, making a drum shape with a faceplate at each end. This drum is cut completely in two, at a point about 22mm above the bottom, completing the cut with a hand saw. Both parts of the cut surface are faced off square and smooth, then reglued together, breaking the joints exactly half and half. The cutting and regluing process is repeated with a section about 32mm wide. After this, the temporary backing block is cut off, leaving the bowl as shown in the final illustration. From this point on the work is simply a matter of turning down the bowl to any desired shape.



and mounted on this chuck. thus mounted, the remaining contours can be turned to shape.

Fig. 47

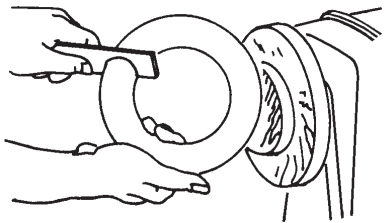
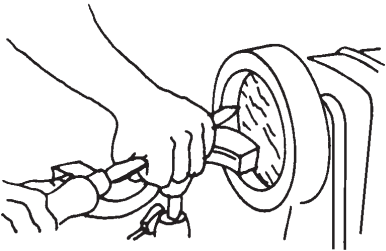
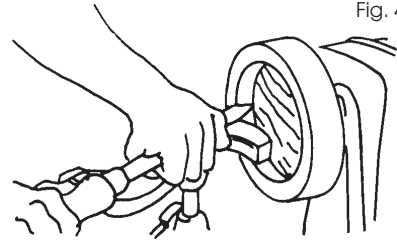

Another method of turning a ring makes use of a recessed chuck. The work stock is mounted on a screw centre and one half of the ring is formed, but the ring is not cut away from its centre. The stock is then removed and a recessed chuck, mounted on the large faceplate, is prepared to receive the ring in a tight press fit.

Fig. 48

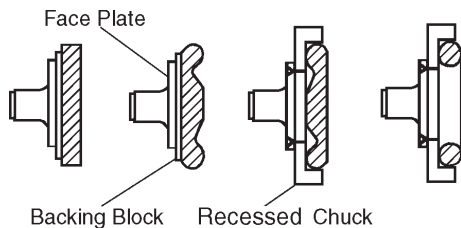

After being chucked the remaining face of the ring can be turned to the proper contour, thus cutting away the centre portion.

Work of this type take constant measurements, or better still, use a template to guard against over or under cutting.

## 5. TURNING BALLS

Fig. 65

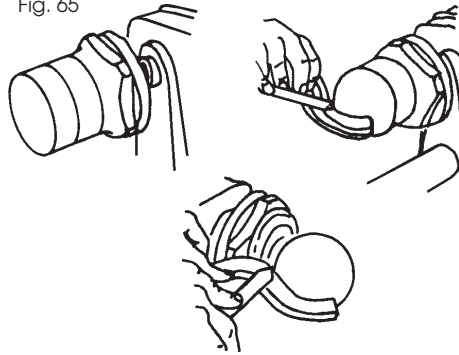

Wooden balls of large size are first roughly turned between centres, using standard procedures. Smaller balls can be mounted as face plates on the small faceplate of screw centre. Lines drawn to indicate the centre and ends of the ball shape are helpful in plotting the curve. A template should always be used for accurate visual observation of the work progress.

Fig. 49

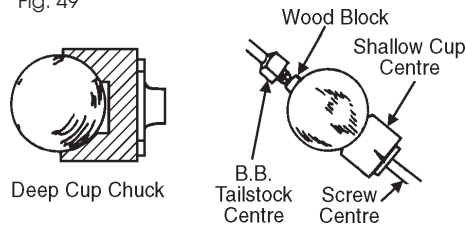

If the ball is mounted as a faceplate turning, almost the entire surface can be turned before it becomes necessary to rechuck it. Rechucking can be accomplished in a deep cut chuck, which will hold the finished portion of the ball in a tight press fit. Another method of rechucking is to use a shallow cup chuck which will not support the ball alone, but must be used in conjunction with the tailstock. When using the shallow chuck, a wood block is fitted to the tailstock so that the ball can revolve upon it. This block should be lubricated with beeswax or grease. In using the shallow chuck method,

## PREPARATION

### 1. SPINDLE TURNING

If you are not experienced at the art of wood turning, we suggest that you practice using the various wood turning tools, starting with turning a small spindle.

Fig. 4

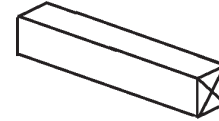

- 1.1 Select a piece of wood 50x50x305mm.
- 1.2 Draw diagonal lines on each end to locate the centres.
- 1.3 On one end, make a saw cut approximately 2mm deep on each diagonal line. This is for the spur centre.

You may also remove the drive centre from the spindle, as described on p.10 'Faceplate Turning', and place the point of the centre on the wood where the diagonal lines cross.

Fig. 5

Wooden Mallet  
or  
Plastic Hammer

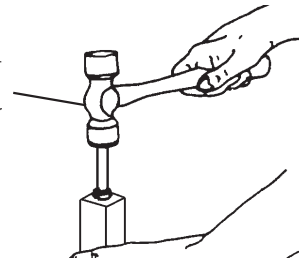

Drive the centre into the wood. Use a wooden mallet or a plastic hammer, but put a piece of wood on the end of the centre to protect it.

- 1.6 Replace the Drive Centre, ensuring it is tight.

### Positioning the Tailstock

- 1.7 Position the tailstock at the appropriate distance for the job in hand. To move the tailstock, slacken the securing nut located underneath. Always allowing a little room for the advancement of the rotating centre.

- 1.8 Place the wood between the centres and advance the tailstock so that the rotating centre is forced into the spindle at the exact centre mark, rotating the spindle as you do so.

- 1.9 Adjust the tool rest approx. 3mm away from the corners of the wood and 3mm above the centre line. Note the angled position of the tool rest base.

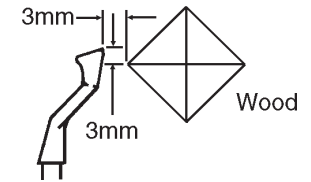

Fig. 6

Lock the tool rest base and the tool rest

**IMPORTANT. ALWAYS rotate the wood by hand to guarantee that the corners do not strike the tool rest..**

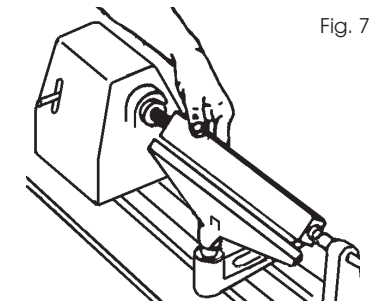

Fig. 7

- 1.10 Check to ensure there are no spanners/wrenches/pieces of wood or other debris in the area, and that your clothing is properly adjusted before pushing the ON button.

The procedure for cutting and the use of woodworking chisels is described under "Using Woodworking Chisels, starting on page 12.

## 2. FACEPLATE TURNING

Turning which cannot be worked through centres, must be mounted on a faceplate, or other work-holding device. (Some jobs may require the use of special chucks).

To attach the face plate, first remove the Drive Centreas follows:

### Removing the Drive Centre

Hold the spindle with the spanner provided, on the flats machined on the spindle.

Using a suitable spanner on the Drive centre, turn it anticlockwise whilst holding the drive centre steady - See Fig 8.

The Face Plate is removed in a similar manner

Fig. 8

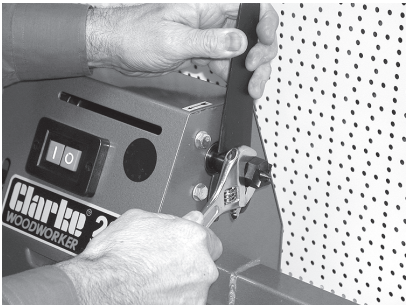

All face plate work is done by scraping. Any attempt to use a cutting technique on edge grain, will result in hogging or gouging, which may tear the tool out of your hands.

For Faceplate turning, the work (suitably trimmed so that it is as near to its final dimension as possible), should be firmly mounted on to the faceplate, using screws as appropriate (see fig. 9).

The complete assembly is then screwed on to the headstock spindle, and tightened securely, by holding the faceplate, and turning the spindle nut using a spanner, to lock it up against the faceplate boss.

The screws used in securing the work to the face plate, must not be of sufficient length as to interfere with the tool at the final dimension. It may be necessary to screw the work to a backing piece, depending upon design, or where screws are not permissible at all, the work may be glued to a backing piece, fitting a piece of paper at the joint, which will allow for later separation without damaging the wood.

Fig. 9

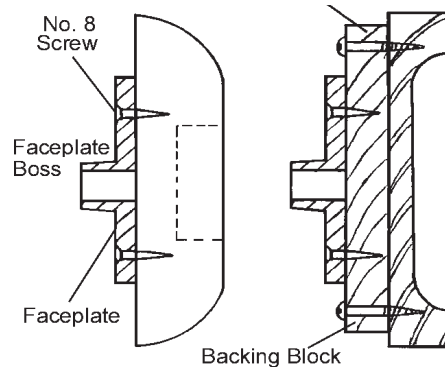

## FANCY FACE PLATE TURNINGS

Fig. 43

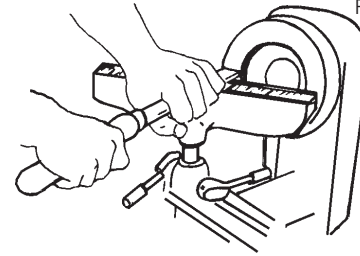

After making a recess at least 1/2 the way through the workpiece, and finishing this on the inside, remove the workpiece from the lathe. Now mount a short length of soft wood stock on the screw centre and turn this down to form a dowel that will be a tight press (not driving) fit inside the recessed end of the cylinder. Mount the cylinder on this wooden chuck, and recess the unworked end deep enough to form a perfect hole through the entire cylinder.

### 1. PREPARING A PLUG CHECK

A plug check is an auxiliary wood chuck mounted onto a faceplate. The chuck can be any size diameter, should be about 65mm thick for stability and should be provided with a 20mm hold in the centre for receiving a tenon turned at the end of the workpiece. Once made, such chucks are permanent useful fixtures for turning balls, goblets etc. In use, the wood stock for turning is turned between centres to produce a tenon at one end which will be a driving fit in the hole of the chuck. When mounted in the chuck, the workpiece is substantially supported for any faceplate type of turning.

### 3. RECHUCKING

Rechucking is the general term used to describe any additional work mounting that is necessary to complete a turning project. The method of working cylinders, and the use of a plug chuck as already described are typical examples. Another good example is the rechucking of a bowl.

Fig. 46

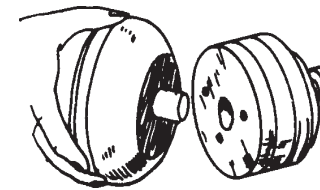
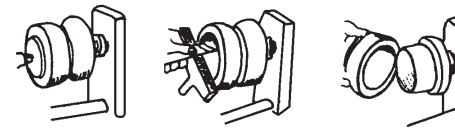

Fig. 44

### 2. TURNING CYLINDERS

Stock for cylinders should be mounted on the screw centre or a small faceplate. The tailstock can be brought up to support the work while the circumference is being turned and finished. Afterwards, the tailstock is backed off and the outer end of the cylinder is recessed, using methods already described for making deep presses.

Fig. 45



The work is mounted on a wood backing block secured to the large faceplate, and is turned in the usual manner, except for the back side (which is against the mounting block). It is then removed from the mounting block. An auxiliary chuck of soft wood is now made in the same manner as that for the cylinder chuck. This chuck must have a turned recess properly sized to accommodate the rim of the bowl in a tight press fit. When the bowl is mounted in this chuck, the bottom can be cleaned off and slightly recessed to complete the desired contours.

### 4. TURNING A RING

One method of turning a ring requires a spindle chuck. The work stock is first mounted to a backing block held by the large faceplate, and is turned to shape on the outer side. The inside diameter of the ring is also shaped, all the way through to the backing block. The work is then removed from the backing block. A spindle chuck is now prepared so that it will be a tight press fit inside the ring, and the ring is reversed

# FACEPLATE & CHUCK TURNINGS

Fig. 40

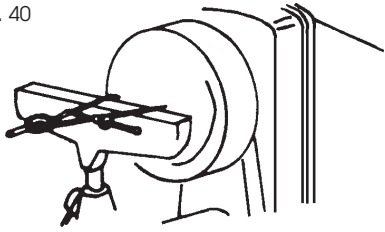

## 1. PLANNING THE WORK

Make a layout first, to provide a visual pattern to follow while working the turning. Patterns can be laid out in the same manner as spindle patterns, or templates can be made which can be held against the work for visual comparison. Circles to locate the various critical points (at which the contours of the faceplate take distinct form) can be quickly scribed on the rotating work by using dividers (see above).

## 2. PLANNING VARIOUS CUTS

The circumference of a faceplate turning is roughed-out and finished in the same manner as that for a spindle. Practically all of the balance of the operations however, are done by using scraping methods.

A few of the standard contours which are often turned are illustrated in Fig.41, which also shows the proper chisels for shaping these contours. Any roughing out to depth that must be done is generally accomplished with the gouge held in the scraping position.

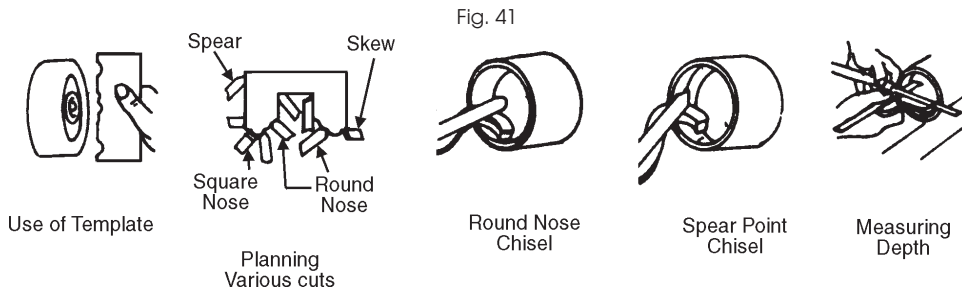

## 3. DEEP RECESSES

Remove the bulk of the waste (to rough-out the desired recess), by scraping with the round-nose chisel or the gouge. Remove up to within 1/8" of finished size in this manner.

Finish off the inside circumference by scraping with the spear point chisel or skew. Smooth the bottom of the recess by scraping it flat with the flat nose chisel.

Fig. 42

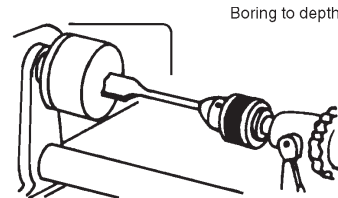

Proper support must be provided at all times for the scraping chisels. Several tool rest positions are shown in the accompanying illustrations. Always endeavour to position the part of the rest that supports the tool as close to the working surface as possible.

The depth and squareness of the sides of the recess can be quickly checked by holding one of the straight sided chisels and a combination square as shown.

The following pages are examples of woodworking operations and illustrations of some of the techniques which are generally used. This is by no means exhaustive, and we strongly recommend that if you are inexperienced in the use of wood lathes, you should read as much as possible on the subject and perhaps subscribe to a good woodworkers periodical.

# USING WOODWORKING CHISELS

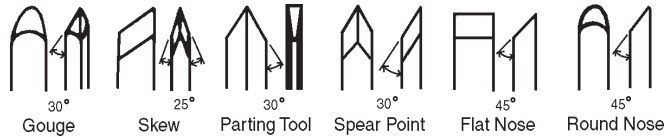

Fig. 10

## THE SIX MOST COMMONLY USED CHISEL TYPES

### 1. SELECTION OF CHISELS

Better chisels have handles approximately 10" (250mm) long, to provide plenty of grip and leverage. Sharp tools are essential for clean, easy work. Buy tools that will take and hold keen edges.

An 8 piece chisel set is available from your CLARKE dealer, part no. 6500649

### 2. THEORY OF TURNING

There are two classes of chisel; these are :

- a. Chisels intended primarily for cutting, and
- b. Chisels used only for scraping.

The cutting chisels are the gouge, skew and parting tool. These are most commonly used. They are sharpened to a razor edge by honing on both sides.

The scraping chisels are the flat nose, round nose and spear point. These are not honed on the flat sides, the wire edges produced by grinding are left on to aid in the scraping process.

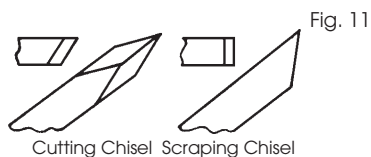

Fig. 11

### 2.1 Cutting and Scraping

To cut, the chisel is held so that the sharp edge actually digs into the revolving work to peel off a shaving.

To scrape, the chisel is held at a right angle to the work surface as shown in fig. 12, and removes fine particles instead of shavings.

Many operations require that the cutting chisels be used for scraping, but scraping chisels are never used for cutting. Scraping dulls a chisel

must faster, especially the razor sharp cutting chisels.

Cutting is faster than scraping and produces a smoother finish which requires less sanding. However, it is far more difficult to master. Scraping, on the other hand, is far more precise and easier to control.

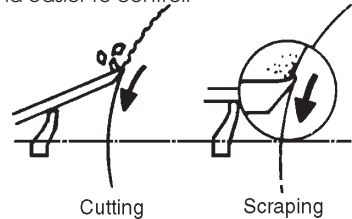

Fig. 12

### 2.2 When You Can Cut and When You Must Scrape.

There are two different types of cut to consider when turning.

One is cutting at the circumference of the workpiece (for example, turning down the outer surface of a cylinder or the inner wall of a hollow round box, as shown in fig. 13). In this approach the surface being turned travels under the chisel edge like an endless belt.

The second type is cutting at the diameter of a workpiece (as when turning the face of faceplate turning or the side of a large shoulder on a spindle turning, as shown in fig. 13). In this approach the surface being turned rotates like a disc under the chisel edge. Sometimes the approach will be a combination of both.

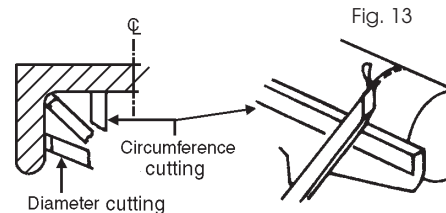

Fig. 13

turning. The first finished turning can also be used as a template.

Attach the template to a board, then mount the board behind the lathe on hinges, so that the template can be moved down to touch the workpiece and allow you to closely observe progress of your work.

If a great many turnings are being produced, a diameter board will save the time used for resetting callipers. This is simply a thin board along the edge of which a number of semicircular cuts have been prepared to represent all the various calliper settings required for measuring the sizing cuts. Each semicircular cut is held against the workpiece instead of using the callipers.

Using a Template



Using a Diameter Board

Fig. 37

### 3. LONG SPINDLES

A long turning can be worked in short sections, with joints arranged to be at shoulders where they will not be noticed.

Long thin work that is likely to whip while turning should be supported at one or two places by a backstick. This is easy to make. A simple one consists of a short length of wood mounted vertically in an extra tool rest, and notched so that it can be used to support the spindle from behind. An improved type which uses 2 roller skate wheels to form the notch-size is shown.

Fig. 38

Use of Backsticks

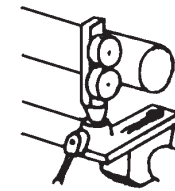
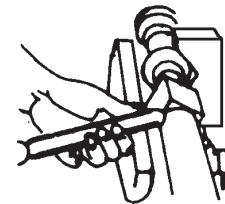

Position the backstick against a pre-turned portion near the centre of the spindle, this portion being at least 3mm over finish size to allow for later removal of any marks made upon it.

Operate lathe at a slower speed than normal. Lubricate the workpiece at point of contact with the backstick, using beeswax (preferably), or grease.

After completing the turning, remove the backstick and finish off the original point of contact. Sand off any slight burns remaining on workpiece.

### 4. CUTTING DOWELS

Dowels of any size can be turned quickly with the simple jig shown. If the stock is prepared as a split or quartered turning, half round and quarter rounds will be produced.

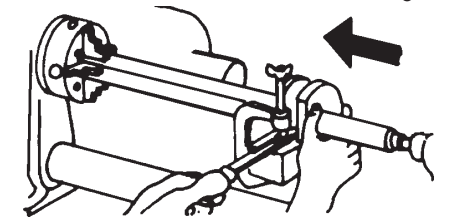

Fig.39

The jig uses a 1/2" gouge as the cutting tool and will produce dowels up to 11mm diameter. Make the jig from suitable hardwood stock as shown.

The hole through the jig must be large enough at the side, to the left of the gouge, to allow passage of the square stock. At the right of the gouge this hole must be just the diameter of the finished dowel. Make the jig so you can hold and guide it by hand.

To start, centre the stock as you would for a spindle turning and turn down about 50mm at the right end to desired size.

Then remove the stock, place your jig over the turned end, with turned portion through the smaller jig hole, and re-centre the stock on the lathe.

Hold the jig firmly and start the lathe. Push the jig slowly right to left along the stock until the whole dowel is complete.



# SPINDLE TURNINGS

## 1. PLOTTING THE SHAPE

Once the basic cuts have been mastered, you are ready to turn out finished work.

The first step is to prepare a plan for the proposed turning. This can be laid out on a suitable sheet of paper, and should be to full size.

Next, prepare the turning stock by squaring it up to the size of the largest square or round section in your plan. The stock can be cut to the exact length of the proposed turning, but in most cases it is best to leave the stock a little long at one or both ends to allow for trimming.

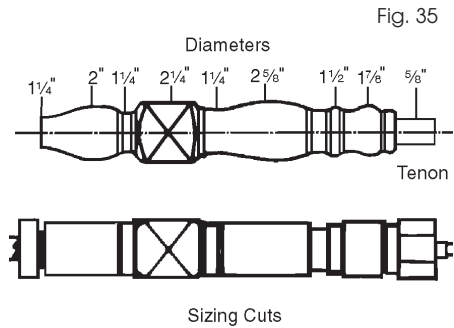

Fig. 35

Mount the stock in the lathe, and rough it off to a maximum size cylinder. Now project your plan on to the turning by marking the various critical dimensions along the length of the spindle in pencil. These dimensions can be laid out with an ordinary ruler, or by using a template. Make the pencil marks about 12mm long, they will be visible when the work is revolved under power, and can be quickly traced around the spindle by touching each line with the pencil.

After marking, use the parting tool to make sizing cuts at all of the important shoulders. When learning, you will find it best to make sizing cuts to accurately plot the various diameters, but experienced workers can do with a few such cuts at the important shoulders.

Plan each sizing cut so that it is in waste stock, and make each deep enough so that there will be just enough wood left under the cut for the finishing process.

Once the sizing cuts have been run in, rough-out the excess wood with a gouge, then proceed with the finishing process by making the various types of cuts required.

## 2. DUPLICATE TURNINGS

Identical turnings require great accuracy when plotting the work and doing the various cuts. Many methods have been devised to assist in perfecting the work.

### 2.1 Use of Patterns

Professional workers generally use a pattern or layout board.

This is a thin piece of wood or cardboard on which is drawn a full-size half section of the turning. The contour of the finished surface is drawn first, then the diameters at various critical points are drawn to scale as vertical lines intersect the contour line.

By placing the pattern against the roughed-out-cylinder, you can quickly mark the various points of the critical diameters.

To make each sizing cut, use outside callipers and set these by actually measuring the length of the vertical line on the pattern which represents the diameter desired. Then make the sizing cut, down to the proper diameter by using the callipers to determine when the cut is finished.

After making the sizing cuts, hang the pattern behind the lathe where it will serve as a guide for completion of the workpiece.

Fig. 36

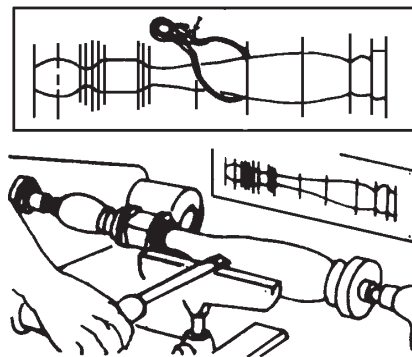

### 2.2 Using a Template and a Diameter Board

When many identical turnings are to be produced, it is convenient to have a prepared template. This can be made of thin wood or cardboard, and is cut on a band saw or scroll saw to have the exact contour of the finished

Either a cutting or scraping action can be used when cutting at the circumference. The shaving is removed like a peeling from a potato.

Scraping only, is used when cutting at the diameter. The reason is obvious when you consider that faceplate turning always requires removal of wood across the grain. Wood does not peel easily across the grain, and attempts to use a cutting method will result in damage to the work and throwing of the chisel by the work.

It follows that a cutting action is used for the majority of spindle turning operations, whilst the majority faceplate turning is done by the scraping method.

When a combination approach is to be used, you will have to judge, by the feel of the work, when to stop cutting and start scraping.

Never try to cut when it becomes difficult to hold the chisel against the roughness of the wood grain.

### 2.3 How To Position The Tool Rest for Circumference Cutting

When cutting, the object is to pierce the outer skin of wood to a certain desired depth, then to hold the chisel steady, with the bevel edge parallel to the work circumference, so that it will peel off a shaving at this desired depth.

The only sure method of holding the chisel steady is to rest the bevel against the work, as shown in sketch 1.

When the tool rest is at the proper height, the chisel can be held with the bevel pressed against the work, and the tool rest will act as a fulcrum to support the chisel against the downward force of the revolving work.

If the rest is placed too low, so that the chisel is held with the bevel out from the work (Sketch 2), the cutting edge will continue to dig deeper into the work. It will dig in until the "bite" becomes so deep that your hands have difficulty holding the

chisel, then the improperly supported chisel will begin to bounce, or chatter, against the workpiece.

If the rest is placed too low, the chisel must be held extremely high to position the bevel against the work (Sketch 3). Then the rest loses most of its value as a fulcrum, and the downward force of the revolving workpiece tends to kick the chisel back out of your hands.

If the rest is placed too high, (Sketch 4) and the chisel is correctly positioned for cutting, it strikes the workpiece near the top where the direction of force exerted by the workpiece is nearly horizontal, and kickback will again result.

If the rest is placed too far out from the work surface (Sketch 5) then, when correctly held, the chisel is again too high on the work. Also, you have less leverage on your side of the tool rest, and it is even more difficult to hold the chisel.

With large diameter work (Sketch 6), the tool rest can be above the workpiece centre line, and somewhat out from the work surface.

With small diameter work (Sketch 7), the rest should not be far from the work surface. As work grows smaller, the rest should be repositioned.

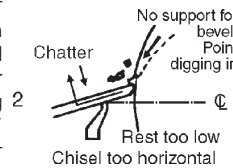
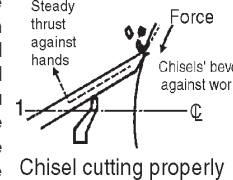
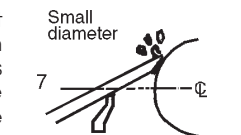
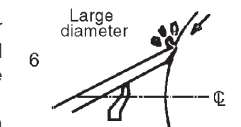
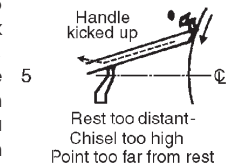
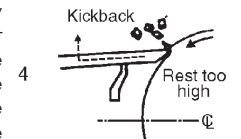
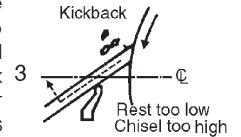

## 2.4 How to Position Tool Rest for Circumference Scraping

In scraping operations, the tool rest position is not as critical as it is for cutting operations. The chisel generally is held horizontally, though it can be held at an angle to reach into tight places. Considering that the wire edge of the chisel does the scraping, sketches 8 and 10 show the results of too low or too high a position for the rest, and sketch 9 shows the chisel action with the rest correctly positioned.

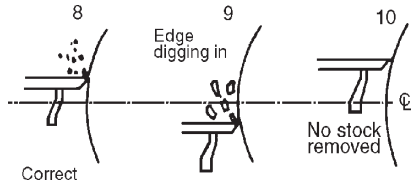

## 2.5 How to Position Chisel and Rest for Diameter Scraping

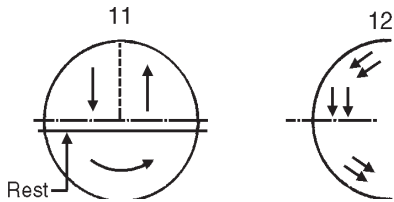

When scraping on the diameter, that portion of surface to the right of centre is moving upwards (Sketch 11). If the chisel is placed in this area, it will simply be carried up off the rest and out of your hands. All diameter scraping operations must be done at the left of centre.

Three different chisel contact points are shown in Sketch 12. It will be noted that, when the chisel is above the workpiece centre, or below it, the work surface sweeps past the chisels' edge at an angle and tends to carry the chisel in one direction or the other along the rest. Only when the chisel contacts the work on the centre line does the work surface pass squarely under the chisels edge. This then, is the position in which it is easiest to hold the chisel steady. To obtain this position, place the rest approximately 1/8" (3mm) - thickness of chisel, below the centre.

## 3. USING THE GOUGE

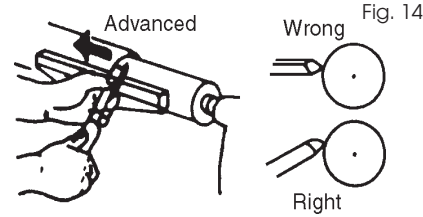

Three gouges the 1/4", 1/2", and 3/4" are ample for general DIY turning, but other sizes from 1/8" to 2" can be purchased.

The main use of the gouge is for rough circumference cutting of raw stock down to a cylinder of working size. It is the best tool to use for rapidly cutting away large areas of the workpiece, but when so used does not produce a smooth surface. With practice, it can be used for cutting coves and the shaping of long cuts. It is also useful for scraping.

When used for cutting, the gouge is always held with the convex side down. It should be rolled approximately 30° to 45° in the direction in which it is being advanced along the rest, and the cutting edge will be a little in advance of the handle.

## 4. USING THE SKEW

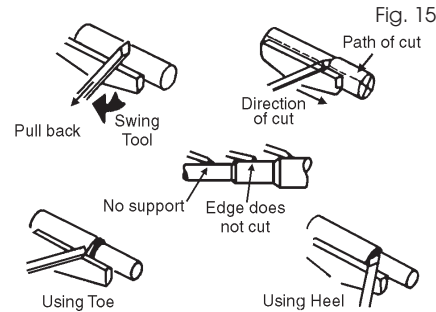

Two skews, the 1/2 and 3/4" sizes, are all that are needed for general use. Other sizes are available. This tool is nearly always used to make finished cuts, to cut vees and beads, and to square shoulders. Properly used, it produces the best finish that can be obtained with a chisel. It should not be used for scraping, as this quickly dulls it.

For finish cutting, the skew is held with the cutting edge considerably in advance of the handle,

Now draw the skew straight back whilst raising the handle slowly, until the edge of the heel at the pencil line starts to cut.

As the edge begins to cut, roll the skew in the direction of the vee, so that the exact portion of the edge, when started cutting, will travel in a 90° arc down to the bottom of the vee.

Upon reaching the bottom of the vee, the skew should be on edge. Reverse the movements to cut the side of the adjacent bead.

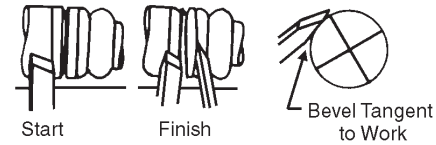

It is important that only the extreme heel should do the cutting. This means that the bottom edge of the bevel, next to the vee, must at all times be tangent to the arc of the bead being formed.

Easier beads can be shaped with a spear point chisel. Use pencil marks and sizing cuts as before. Push the chisel straight into each cut and rotate it horizontally to round off the adjacent edges. It must be moved slightly in the direction of rotation at the same time, to keep the point from digging into the adjacent bead.



## 8. CUTTING COVES (CONCLAVES)

This is the most difficult single cut to master, but one of the most important in good wood turning. First, use pencil marks to indicate the edges. Then rough-it out to within about 3mm of the desired finish surface by scraping with the gouge or round nose chisel. If the cove is to be very wide, sizing cuts can be made to plot the roughing out.

Once it is roughed out, the cove can be finished in two cuts, one from each side to the bottom centre.

At the start of either cut, the gouge is held with handle high and the two sides of blade held between the thumb and forefinger of tool rest hand, just behind the bevel.

Position the fingers ready to roll the blade into cove. Hold the blade so that bevel is at a 90° angle to the work axis, with the point touching the pencil line and pointing into work axis.

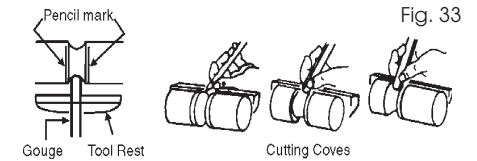

From here, depress the tip slightly to start the cut, then continue to move tip down in an arc toward the bottom centre cove, at the same time rolling chisel uniformly so that at the end of the cut it will be flat at the bottom of the cove. The object is to keep the extreme tip of the gouge doing the cutting from start to finish. Reverse movements to cut the opposite side.

Coves can be scraped to finish using the round nose chisel or a file, but these methods do not generally produce perfectly curved coves.

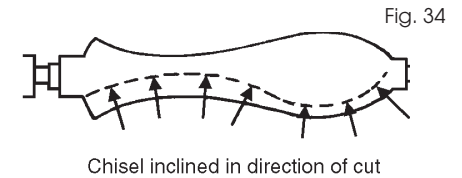

## 9. MAKING A LONG CONVEX CUTS

First turn work down to approximate size, using sizing cuts (as required) to determine various diameters. Finish cut can then be made with either skew or gouge.

If the skew is used, the principles of operation are the same as those employed in cutting a bead, except that the curve is longer and may be irregular. Use the extreme heel throughout. Start at the longer end of the curve (if curve is irregular) and progress toward the steeper end. If a gouge is used, make the cut in the same direction. Start with the handle well back from the point, swinging it in the direction of tool travel to overtake the point, if necessary, when the steep part of the curve is reached. The object is to keep the extreme point doing the cutting throughout, with the bevel at a tangent to the curve as much as possible.

## 10. MAKING LONG TAPER CUTS

Long taper cuts are made like long convex cuts, with the skew or gouge. However, the angle between the cutting edge and handle is kept constant during the entire cut. The handle is not swung around. Always cut downhill. Do not cut too deeply at the centre of the taper.

## 5. CUTTING A SHOULDER

A shoulder can be the side of a square portion left in the workpiece, the side of a turned section or the end of the workpiece. Most shoulders are perpendicular to the work axis, but a shoulder can be at any angle desired.

Fig. 28

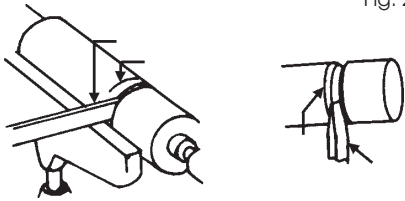

First, mark position of the shoulder with a pencil held to the revolving workpiece. Then make a sizing cut with the parting tool, placing this cut about 2mm outside the shoulder position and cutting to within about 3mm of the depth desired for the area outside of the shoulder.

If shoulder is shallow, the toe of the skew can be used to make the sizing cut, but do not go in deeper than 3mm with the skew unless wider and wider vees are cut to provide clearance for this tool.

Fig. 29

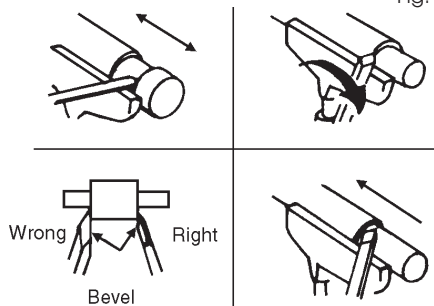

Use the gouge to remove any waste stock outside of shoulder, and smooth this section up to within 3mm of the shoulder in the usual manner. Finishing of the shoulder unless it is more than 25mm high is best done with the 1/2" skew. First, the toe of the skew is used to remove shavings from the side of the shoulder, down to finish size. Hold the skew so the bottom edge of the bevel, next to shoulder, will be very nearly parallel to side of shoulder, but with the cutting edge turned away at the top, so that only the extreme toe will do the cutting.

If the cutting edge is flat against the shoulder, the chisel will run. Start with the handle low, and raise handle to advance toe into the work.

Cut down to finished diameter of outside area, then clean out the corner by advancing the

heel of the skew into it along the surface of the outside area.

Tilt the cutting edge with handle raised up, so that only the extreme heel does this cutting. If the shoulder is at the end of work, the process is called squaring the end. In this case, reduce outer portion to a diameter about 6mm larger than tool centre diameter, then later saw off the waste stock.

## 6. CUTTING VEEES

Vee grooves can be cut with either the toe or heel of the skew. When the toe is used, the cutting action is exactly the same as in trimming a shoulder, except that the skew is tilted to cut at the required bevel. Light cuts should be taken first on one side then the other, gradually enlarging the vee to the required depth and width.

Fig. 30

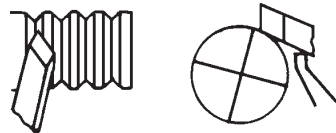

When the heel is used, the skew is rotated down into the work, using the rest as a pivot. Otherwise, the cutting position and sequence of cuts is the same.

As when using the toe, it is important that cutting be done only by extreme end of cutting edge.

If deep vees are planned, it is quicker to start them by making a sizing cut at the centre of each vee. Vees can also be scraped with the spear point chisel or a three-sided file.

## 7. CUTTING BEADS

This requires considerable practice.

First, make pencil line to locate the tops (highest points) of two or more adjoining beads. Then make a vee groove at the exact centre between two lines, and down to the desired depth of the separation between the beads.

Be careful not to make the groove too wide or you will remove portions of the desired beads.

The sides of the two adjoining beads are now cut with the heel of the skew, preferably 1/2" size, unless beads are quite large. Place the skew at right angles to the work axis, flat against the surface and well up near the top. The extreme heel should be just inside the pencil line that marks the top of the bead.

bevel side down, keep the base of the bevel against the work. Good practice is to place the skew well over the work, pull it back until the edge begins to cut, then swing the handle into position to advance the cut. Both the toe and the heel of the skew can be used for taking light cuts, but do not penetrate the wood too deeply without cutting clearances, as there is danger of burning the tip of the tool.

## 5. USING THE PARTING TOOL

Fig. 16

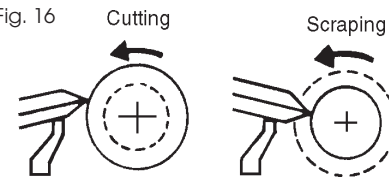

The parting tool has just one primary purpose to cut straight into the workpiece as deep as desired, or all the way through to make a cut-off, it is therefore a very narrow tool. 1/8 inch wide and shaped to cut its own clearance so that the edge will not be burned. When used for scraping, however, it should be backed off regularly to prevent overheating.

Unlike the gouge and skew, the parting tool is seldom held with the bevel against the work. As the amount of stock removed is small, a support for the bevel is not necessary. The tool is simply fed into the work at an angle (for cutting), or pointed at the workpiece centre (for scraping) it can be held easily in one hand.

## 6. USING THE SCRAPING CHISELS

Fig. 17

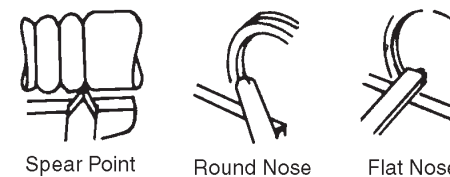

A 1/2" wide spear point chisel, a 1/2" wide round nose chisel and a 1" wide flat nose chisel complete the list of tools ordinarily used by home craftsmen. Each of these scraping chisels can be purchased in various other sizes for special purposes. All are very useful for diameter scraping operations and for circumference

scraping, when cutting methods cannot be employed.

The spear point is used for fine scraping and delicate operations, such as the forming of beads, parallel grooves and shallow vees. Edges and bowl contours can be rounded with the round nose chisel. Any flat surface can be scraped with the flat nose chisel.

## 7. USING SHAPER/MOULDING KNIVES

Fig. 18

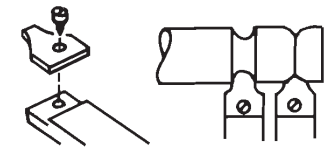

An old chisel can be made to serve as a holder for 'shaper' or 'moulding' knives. Such knives make it possible to scrape many interesting shapes in the workpiece surface in one or two operations instead of the many operations required with standard chisels. It is generally not practical to use cutting methods with special shape tools, scraping methods should be used.

The holder should provide a shoulder against which the butt end of the knife can be firmly seated, and the knife must be securely mounted, either by means of a screw threaded into the holder, or be compressing it between two prongs bolted together.

## 8. USING A BLOCK PLANE

Fig. 19



Clear glass smooth finishes (especially on soft woods) can be obtained by using a block plane set to take a fine shaving. The tool rest should be raised up approximately to the top of the workpiece, and the plane should be horizontal, but turned slightly in the direction of travel so that it will take a shearing cut. Two tool rests, one in front and the other behind the work, can be used to advantage in positioning the plane so as to exactly limit the depth of cut (and finished size of the workpiece).



## 9. USING WOOD RASPS AND FILES

Fig. 20

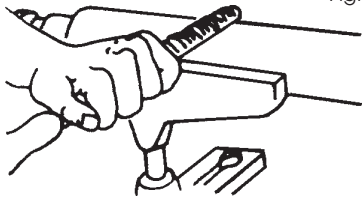

A wood rasp will remove stock quickly when held against the revolving workpiece. Care should be taken to support the rasp firmly against the tool rest however, as it can tear the hands painfully if caught by a rough edge of the workpiece and kicked back. The rasp will leave a very rough finish.

Finer finishes (similar to those produced by scraping), can be obtained by using files in the same manner. Various shape files can be used for shaping vees, beads, coves etc. If pressed into the wood too hard, however, a file can burn the workpiece surface. Keep the file clean to keep it cutting uniformly. Files work best on hard woods.

## 10. HAND POSITIONS

When handling a chisel, the hand takes a natural position, being nearer or farther from the end depending upon the amount of leverage required. The position of the tool rest hand is a matter of individual liking, but there are three generally accepted positions, each best for certain types of operations.

### 10.1 Roughing Off

Roughing Off

Fig. 21

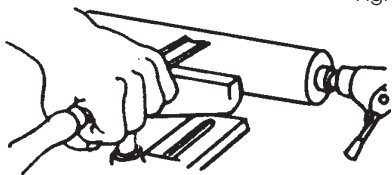

Roughing off and other heavy work requires a firm grip and solid positioning of the chisel against the rest. This is best obtained by the tool rest hand position as illustrated. The wrist is dropped down so that the heel of the hand below the little finger acts as a sliding guide against the rest. The handle hand controls chisel position.

### 10.2 Finish Cutting

Finish Cutting

Fig. 22

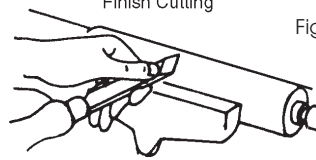

Finish cutting requires more control with less force and is better done with the palm of the tool rest hand turned up. The wrist is still held down, and the side of the index finger acts as a guide along the rest. In this position, control of the chisel is shared by both hands, the fingers of the tool rest hand being free to assist in positioning the tool.

### 10.3 Intricate Cutting

Intricate Cutting

Fig. 23

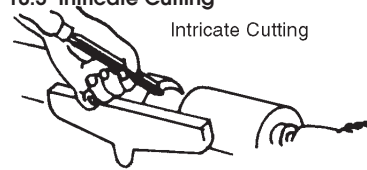

Intricate, delicate cutting requires extreme control, with practically no force. This is best accomplished by guiding the chisel with the fingers of the tool rest hand. The hand is held palm up, with the wrist high, and the little finger placed against the rest to steady the hand. The chisel does not touch the rest and the handle hand is completely secondary to the tool rest hand.

The first and second positions are equally good for scraping operations, but the third position is never used for scraping.

Cutting to Depth

Fig. 24

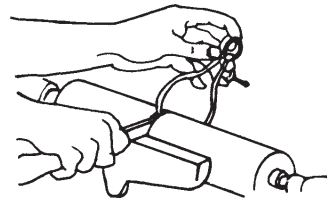

## 11. CUTTING TO DEPTH

Many scraping operations and cutting to depth with the parting tool can be easily done with one hand. The chisel is grasped firmly with the index finger on top, to press it down against the rest, and is thrust straight into the work. Holding the tool thus leaves the other hand free to hold a pattern, callipers etc., to check work progress.

## MAKING STANDARD CUTS

### 1. THE ROUGHING OFF-CUT

Reducing a square or odd shaped workpiece down to a cylinder of approximate size for finish turning is called roughing-off. Faceplate turnings and large diameter spindles should first be partly reduced by sawing, but small spindles are easily turned down entirely with the large (3/4") gouge.

Fig. 25

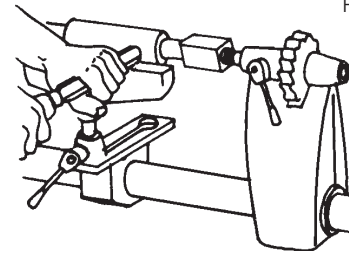

Start the first cut about 50mm from tailstock and then run it toward the tailstock and off the end of the workpiece.

Next, start another cut 50mm nearer the headstock and run it also toward tailstock to merge with first cut.

Continue in this manner until 50mm to 100mm from the headstock end, then reverse the direction of tool travel and work one or two cuts in succession toward the headstock and off this end of the workpiece.

Never start a cut directly at the end. If the chisel catches the end, it will damage the workpiece.

Never take long cuts while corners remain on the work, as this tends to tear long slivers from the corners.

Fig. 26

First Cuts

Testing Roundness

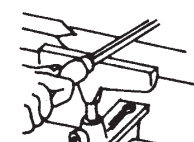
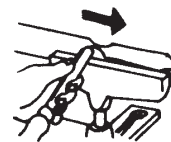

The first series of cuts should not be too deep. It is better to partially reduce the work to a cylinder along its complete length, then start a second series of cuts to reduce it to a cylinder. Once a cylinder has been formed, step the lathe up to its next fastest speed. Further reductions in size can now be carried out by cutting as deeply

as desired at any spot along the work.

At this stage long cuts from the centre of either end can also be taken. Roughing-off generally is continued until the cylinder is approximately 3mm larger than the desired finished size. Roundness can be tested by laying the gouge on top of the work - it will not ride up and down when cylinder is perfectly round.

### 2. ROUGH-CUTTING TO SIZE

A Sizing Cut

Fig. 27

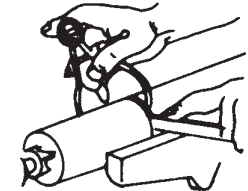

The roughing-off cut can be made to accurately size the cylinder to a given diameter.

Another method is to make a number of sizing cuts at intervals along the work, then use the gouge to reduce the whole cylinder down to the diameter indicated by these cuts.

### 3. MAKING SIZING CUTS

Sizing cuts are useful to establish approximate finish-size diameters at various points along a workpiece. The work can then be turned down to the diameters indicated and be ready for finishing.

Diameters for sizing cuts should be planned to be about 3mm greater than the desired finished diameters.

A sizing cut is made with the parting tool. Hold the tool in one hand and use the other hand to hold an outside calliper, preset to the desired sizing-cut diameter.

As the cut nears completion, lower the chisel point more and more into a scraping position. When the callipers slip over the workpiece at the cut, the cut is finished.

### 4. SMOOTHING A CYLINDER

The final 3mm can be removed in two ways. Either use the 3/4" skew, working from the centre toward both ends and taking lighter and lighter cuts until finished.