

Clarke®



**400W SUBMERSIBLE PUMP WITH FOLDING
BASE AND FLOAT SWITCH**

MODEL NO: PSV6A

PART NO: 7230695

OPERATION & MAINTENANCE INSTRUCTIONS

UK
CA | CE



ORIGINAL INSTRUCTIONS

GC1221 rev 5

INTRODUCTION

Thank you for purchasing this CLARKE 400W Submersible pump with folding base and float switch.

This pump is designed for pumping clean water and water containing solid bodies (max 30mm in diameter). **It is NOT designed for pumping slurry, sludge, mud or heavily polluted water, or any water containing chemicals or other acidic contaminants including salt water.**

GUARANTEE

This product is guaranteed against faulty manufacture for a period of 12 months from the date of purchase. Please keep your receipt which will be required as proof of purchase.

This guarantee is invalid if the product is found to have been abused or tampered with in any way, or not used for the purpose for which it was intended.

Faulty goods should be returned to their place of purchase, no product can be returned to us without prior permission.

This guarantee does not effect your statutory rights.

ENVIRONMENTAL RECYCLING POLICY



Through purchase of this product, the customer is taking on the obligation to deal with the WEEE in accordance with the WEEE regulations in relation to the treatment, recycling & recovery and environmentally sound disposal of the WEEE.

In effect, this means that this product must not be disposed of with general household waste. It must be disposed of according to the laws governing Waste Electrical and Electronic Equipment (WEEE) at a recognised disposal facility.

OVERLOAD SWITCH

These pumps are fitted with a thermal overload switch. If the pump overheats for any reason, it will automatically switch the pump OFF. Once the pump has cooled (at least 5-10 minutes), the pump will automatically restart.

SAFETY INSTRUCTIONS

GENERAL

1. Read all instructions before use and save these instructions for future use.
2. An approved residual current device (RCD) which has a tripping current of less than 30mA **MUST** be used for all operations.
3. The electrical supply must be the same as that on the rating plate.
4. Always make sure that your hands are dry when connecting or disconnecting from the mains supply.
5. Never pull the mains lead to disconnect the pump from the mains socket.
6. The mains plug must be kept away from the water at all times.
7. Do not allow children or unauthorised people to touch the pump, cables or connections.
8. Disconnect the pump from the mains supply when not in use.
9. If necessary have the pump repaired by a qualified person.
10. Keep the mains lead away from heat, oil and sharp edges.
11. If you have to use an extension lead with this product, it must be designed for outdoor use and incorporate a cable suitable for use with Class I appliances.
12. Disconnect the pump from the electrical supply and wear gloves during servicing or maintenance.

PUMP SPECIFIC

1. Do not pump explosive / flammable liquids or chemicals.
2. Never allow the pump to run dry or operate out of the water.
3. Submersible pumps should always be submerged and stored vertically.
4. Disconnect the pump from the mains supply before placing it into or removing it from the water.
5. Always check the plug, and all cables for damage before use.
6. Do not use the pump if damaged. Refer to qualified service personnel for repair.
7. Never carry or lower the pump by the power cable or float switch always use the handle or a rope tied securely to the handle.
8. Never insert your fingers into the pump whilst it is connected to the mains.
9. Never use the submersible pump in a swimming pool when there are people or animals in the pool.
10. Keep the pump clear of any sediment by standing it on a platform or brick or suspending it at a suitable depth.
11. Do not use the pump if the water is liable to freeze, as this can cause damage to the pump. Remove the pump from the water and store it in a frost free location.

ELECTRICAL CONNECTIONS



WARNING: READ THESE ELECTRICAL SAFETY INSTRUCTIONS THOROUGHLY BEFORE CONNECTING THE PRODUCT TO THE MAINS SUPPLY.

Connect the mains lead to a standard, 230 Volt (50Hz) electrical supply through an approved 13 amp BS 1363 plug, or a suitably fused isolator switch. If the plug has to be changed because it is not suitable for your socket, or because of damage, it must be removed and a replacement fitted, following the wiring instructions shown below. The old plug must be discarded safely, as insertion into a power socket could cause an electrical hazard.



**WARNING: THE WIRES IN THE POWER CABLE OF THIS PRODUCT ARE COLOURED IN ACCORDANCE WITH THE FOLLOWING CODE:
BLUE = NEUTRAL BROWN = LIVE YELLOW AND GREEN = EARTH**

If the colours of the wires in the power cable do not agree with the markings on the plug.

- The BLUE wire must be connected to the terminal marked N or coloured black.
- The BROWN wire must be connected to the terminal marked L or coloured red.
- The YELLOW AND GREEN wire must be connected to the terminal marked E or \perp or coloured green.

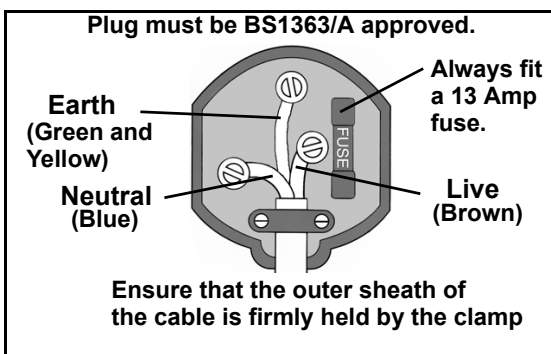

AN APPROVED RESIDUAL CURRENT DEVICE (RCD) WHICH HAS A TRIPPING CURRENT OF LESS THAN 30 mA MUST BE USED.

If you are not sure, consult a qualified electrician. DO NOT try to do any repairs.

ASSEMBLY

Remove all packaging and make sure that the unit has no visible damage. Dispose of all packaging appropriately.

FITTING THE ELBOW

1. Screw the elbow into the outlet port as shown.
2. Connect a suitable hose (not supplied) to the pump outlet.
 - Suitable hoses are available from your local Clarke dealer.



FITTING THE HOSE ADAPTER

A hose adaptor can be screwed onto the elbow if required.

1. Trim the adaptor to the required size.
 - Reducing the hose diameter will effect the maximum flow rate.
2. Connect a suitable hose (not supplied) to the pump outlet.
 - Suitable hoses are available from your local Clarke dealer.



FOLDING BASE

The pump has three folding feet fitted to the base

- When the feet are in the closed position, the space between the base of the pump and the supporting surface is reduced to around 5 mm, limiting the passage of solids in suspension. **when the feet are closed the pump should only be used for pumping clean water.**
- When the feet are opened the pump can be used with solids in suspension of up to a rated maximum of 30 mm.

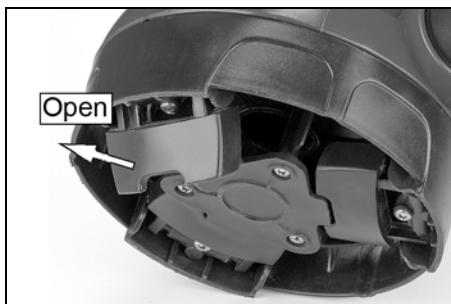

SETTING UP THE PUMP

POSITIONING THE PUMP

1. Place the pump on a flat surface in the area that you want to drain.
 - If there is sediment in the operating area, the pump should be placed vertically on house bricks, or similar.
 - Ensure the pump is positioned with adequate space so that the movement of the float switch is not restricted - recommended minimum area of 50 x 50cm.
 - ALWAYS raise and lower the pump using a rope attached to the lifting handle.
 - Take all necessary precautions as described on page 3.

USING THE PUMP



WARNING: CHECK THE PUMP FOR DAMAGE BEFORE USE, DO NOT USE THE PUMP IF IT IS DAMAGED IN ANY WAY.

WARNING: THE WATER BEING PUMPED WILL BE POLLUTED IF THIS PUMP BECOMES DAMAGED AND LUBRICANT WITHIN THE PUMP ESCAPES.

1. Connect the mains plug to the mains supply.
 - Always use a high sensitivity residual current device (RCD) which has a tripping current of less than 30mA.
2. Switch the mains power supply on.
 - The pump will begin to drain water.
 - As the water level falls, so will the float switch, until it stops the pump.
 - You can adjust the position at which the float switch lead clips to the side of the pump. Adjusting the length of the float switch lead will change the depth of water at which the pump will turn on or off.
3. When pumping is finished, disconnect the pump from the mains power supply.

IMPORTANT: Do not allow the pump to run dry.

MAINTENANCE



WARNING: BEFORE CHECKING THE CONDITION OF THE PUMP, ENSURE IT IS UNPLUGGED FROM THE MAINS SUPPLY. IF THE UNIT IS HARD WIRED, ENSURE THE CIRCUIT BREAKER IS OPEN.

This pump should require no maintenance other than regular cleaning.

If the pump starts to show signs of wear or damage, contact your CLARKE dealer for advice.

CLEANING

1. Check the pump installation regularly to ensure the water inlet is clear of leaves or other debris.
2. Take extra care to remove any debris from around the impeller.

NOTE: Do not attempt to repair the pump yourself, as you may damage the waterproof seal and invalidate your guarantee. Repairs must be carried out by your CLARKE dealer, or contact the CLARKE Service Department, on 020 8988 7400.

STORAGE

When the pump is not being used for extended periods, clean and dry it thoroughly and store in indoors.

SPECIFICATIONS

Voltage	230V~50Hz
Outlet Thread Diameter	1½" BSP
Power	400W
Maximum Head Height	5 m
Maximum Depth	7 m
Maximum Flow	133 l/min
Maximum Water Temperature	35°C
Maximum Particle Size	30 mm
Weight	4.10 kg
Cable Length	10 m
Dimensions (D x W x H)	156 x 163 x 312 mm

TROUBLESHOOTING

PROBLEM	SOLUTION
PUMP WILL NOT START	<ol style="list-style-type: none"> 1. Make sure that the power is switched on. 2. Check fuse (consult an electrician if in doubt). 3. If an extension lead is fitted, check connections (consult an electrician if in doubt). 4. Internal thermal cut-out has not re-set. Leave for 5-10 minutes and try again. 5. The impeller may be jammed. Disconnect from the mains supply and remove any objects that may be obstructing the impeller. 6. Float switch may be jammed against side wall, or prevented from moving. 7. If the pump still fails to start, consult your CLARKE dealer for advice.
PUMP WILL START BUT NOT PUMP	<ol style="list-style-type: none"> 1. Check that the inlet is not blocked. 2. Check that the outlet is not clogged or obstructed. 3. The head may be too great, i.e. you are trying to lift the water too great a distance for the pump to cope with. ("Specifications" on page 7). 4. Air bubble in the pump, produced during immersion. immerse the pump again, at an angle, and shake it whilst lowering to remove any air trapped in the system. 5. Impeller may be damaged - Consult your CLARKE dealer.
PUMP WILL NOT STOP	<ol style="list-style-type: none"> 1. Float switch may be prevented from moving to the fully down position. 2. Float switch may be faulty. Consult your CLARKE dealer for advice.
PUMP STOPS RUNNING	<ol style="list-style-type: none"> 1. Thermal overload has operated. Leave for 5-10 minutes and try again. 2. Pump has run dry, or float switch has cut in. 3. A foreign object has jammed the impeller.

If this does not solve your problem, please contact the Clarke service department.

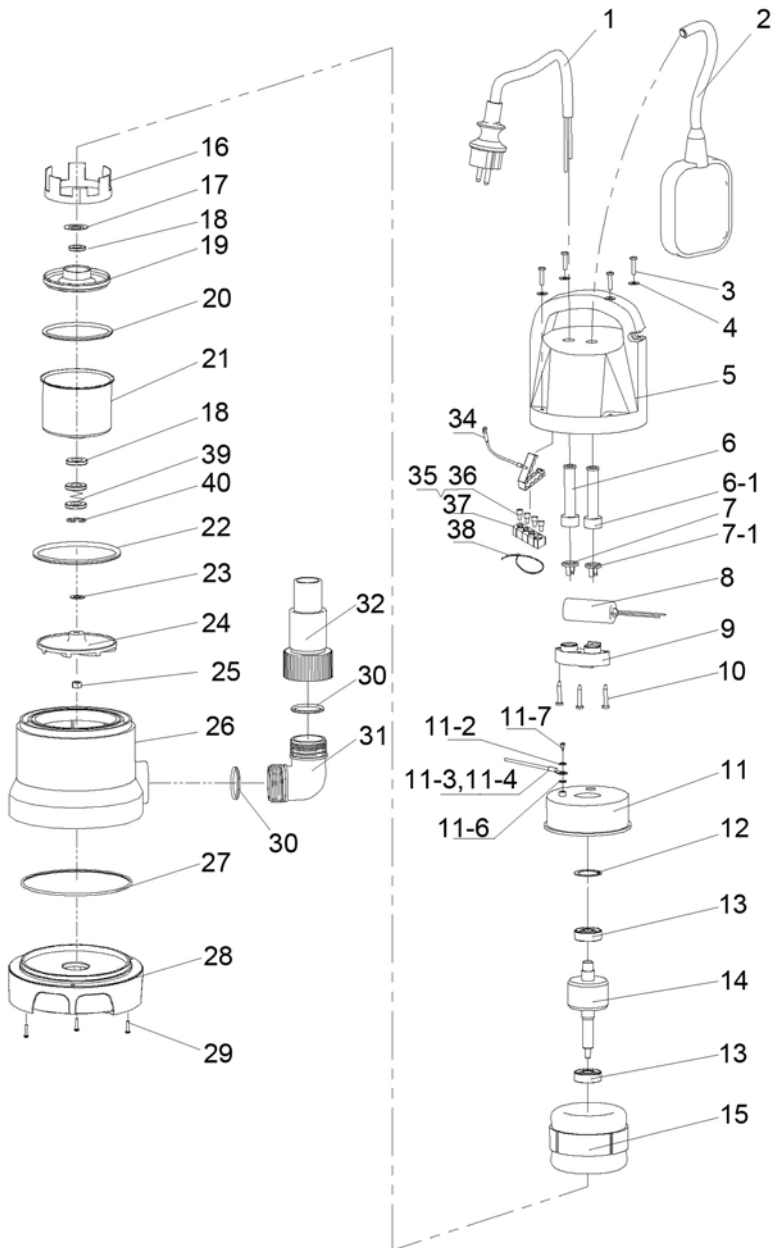

PARTS LIST & DIAGRAM





PARTS LIST

1	Power Cable And Plug	17	Gasket
2	Float Switch	18	O-ring
3	Self Tapping Screw	19	Aluminium Bushing
4	Gasket	20	O-ring
5	Pump Housing	21	Front Cover
6	Cable Sheath	22	O-ring
6.1	Cable Sheath	23	Adjustable Washer
7	Cable Gland	24	Impeller
7.1	Cable Gland	25	Nut
8	6uf Capacitor	26	Main Pump Housing
9	Cable Block	27	O-ring
10	Self Tapping Screw	28	Pump Base
11	Rear Cover	29	Self Tapping Screw
11.2	Gasket	30	O-ring
11.3	Yellow-green Wire	31	Elbow
11.4	Lug Plate	32	Outlet Connector
11.6	Gasket	34	Ground Cover
11.7	Bolt	35	Nylon Pressing Cap
12	Wave Washer	36	Nylon Pressing Cap
13	Bearing	37	Rubber Clip
14	Rotor	38	Ribbon
15	Stator	39	Mechanical Seal
16	Bush	40	Protective Ring

DECLARATIONS OF CONFORMITY

	 Fitzwilliam Hall, Fitzwilliam Place, Dublin 2
DECLARATION OF CONFORMITY This is an important document and should be retained.	
We hereby declare that this product(s) complies with the following directive(s): 2014/30/EU Electromagnetic Compatibility Directive 2014/35/EU Low Voltage Equipment Directive 2011/65/EU Restriction of Hazardous Substances (amended by (EU) 2015/863).	The following standards have been applied to the product(s): EN 55014-1:2017+A11, EN 55014-2:2015, EN 61000-3-2:2019, EN 61000-3-3:2013+A11, EN 60335-1:2012+A11+A13, EN 60335-2-41:2003+A1+A2, EN 62233:2008, IEC 62321-1:2013, IEC 62321-2:2013, IEC 62321-3-1:2013, IEC 62321-5:2013, IEC 62321-4:2013+AMD1:2017CSV, IEC 62321-7-1:2015, IEC 62321-7-2:2017, IEC 62321-6:2015, ISO 17075:2017.
The technical documentation required to demonstrate that the product(s) meets the requirements of the aforementioned directive(s) has been compiled and is available for inspection by the relevant enforcement authorities.	The CE mark was first applied in: 2012
Product Description: Submersible pump(s) Model number(s): PSV7A, PSV6A, PSV5A Serial / batch Number: N/A Date of issue: 13/12/2021	Signed:  J.A. Clarke Director
PSVMA CE CLARKE DOC 121321 Page 1 of 1	

	 Hemmell Street, Epping, Essex CM16 4LG
DECLARATION OF CONFORMITY This is an important document and should be retained.	
We hereby declare that this product(s) complies with the following statutory requirement(s): Electromagnetic Compatibility Regulations 2016 Electrical Equipment (Safety) Regulations 2016 The Restriction of the Use of Certain Hazardous Substances in Electrical and Electronic Equipment Regulations 2012	The following standards have been applied to the product(s): EN 55014-1:2017+A11, EN 55014-2:2015, EN 61000-3-2:2019, EN 61000-3-3:2013+A11, EN 60335-1:2012+A11+A13, EN 60335-2-41:2003+A1+A2, EN 62233:2008, IEC 62321-1:2013, IEC 62321-2:2013, IEC 62321-3-1:2013, IEC 62321-5:2013, IEC 62321-4:2013+AMD1:2017CSV, IEC 62321-7-1:2015, IEC 62321-7-2:2017, IEC 62321-6:2015, ISO 17075:2017.
The technical documentation required to demonstrate that the product(s) meets the requirements of the aforementioned legislation has been compiled and is available for inspection by the relevant enforcement authorities.	The UKCA mark was first applied in: 2021
Product Description: Submersible pump(s) Model number(s): PSV7A, PSV6A, PSV5A Serial / batch Number: N/A Date of issue: 13/12/2021	Signed:  J.A. Clarke Director
PSVMA UKCA CLARKE DOC 121321 Page 1 of 1	

A SELECTION FROM THE VAST RANGE OF

Clarke®

QUALITY PRODUCTS



AIR COMPRESSORS

From DIY to industrial, Plus air tools, spray guns and accessories.

GENERATORS

Prime duty or emergency standby for business, home and leisure.

POWER WASHERS

Hot and cold, electric and engine driven - we have what you need

WELDERS

Mig, Arc, Tig and Spot. From DIY to auto/industrial.

METALWORKING

Drills, grinders and saws for DIY and professional use.

WOODWORKING

Saws, sanders, lathes, mortisers and dust extraction.

HYDRAULICS

Cranes, body repair kits, transmission jacks for all types of workshop use.

WATER PUMPS

Submersible, electric and engine driven for DIY, agriculture and industry.

POWER TOOLS

Angle grinders, cordless drill sets, saws and sanders.

STARTERS/CHARGERS

All sizes for car and commercial use.



PARTS & SERVICE: 0208 988 7400

Parts Enquiries
Parts@clarkeinternational.com

Servicing & Technical Enquiries
Service@clarkeinternational.com

SALES: UK 01992 565333 or Export 00 44 (0)1992 565335

Clarke INTERNATIONAL Hemnall Street, Epping, Essex CM16 4LG
www.clarkeinternational.com