

A SELECTION FROM THE VAST RANGE OF

ClarkeTM

QUALITY PRODUCTS

AIR COMPRESSORS

From DIY to industrial. Plus air tools, spray guns and accessories.

GENERATORS

Prime duty or emergency standby for business, home and leisure.

POWER WASHERS

Hot and cold, electric and engine driven - we have what you need.

WELDERS

Mig, Arc, Tig and Spot. From DIY to auto/industrial.

METALWORKING

Drills, grinders and saws for DIY and professional use.

WOODWORKING

Saws, sanders, lathes, mortisers and dust extraction.

HYDRAULICS

Cranes, body repair kits, transmission jacks for all types of workshop use.

WATER PUMPS

Submersible, electric and engine driven for DIY, agriculture and industry.

POWER TOOLS

Angle grinders, cordless drill sets, saws and sanders.

STARTER/CHARGERS

All sizes for car & commercial use.



ClarkeTM

POWER WASHER

WASHER



KING 135

HOT WASHER

Part No. 7320512

OPERATING & MAINTENANCE

INSTRUCTIONS

Clarke INTERNATIONAL

For spare parts and servicing, please contact your nearest dealer, or Clarke International on

020 - 8988 - 7400

e-mail: Parts@clarkeinternational.com e-mail: Service@clarkeinternational.com





DECLARATION OF CONFORMITY

We declare that this product complies with the following standards/directives

- 89/336/EEC
- EN 292/2/91
- EN 60335-1/88
- 73/23/EEC
- 98/37/EEC
- 93/68/EEC
- 2000/14 EEC

Serial No.....See product data plate

Signed 

SPECIFICATIONS

Motor	230V 50hz
Power Rating	2.0kW
Fuse Rating	13Amps
Sound Power Level	73dB _{WA}
Pump Pressure	100bar (1500psi)
Hot Wash Operating Temp.	90°C
Water Flow Rate	8.3 l/min
Fuel Capacity	4 litres (1 gal)
Dimensions	600X400X680mm

Please note that the details and specifications contained herein, are correct at the time of going to print. However, CLARKE International reserve the right to change specifications at any time without prior notice. Always consult the machine's data plate

© Copyright, Clarke International. All rights reserved, July 2002

SAFETY PRECAUTIONS

WARNING

Water at high pressure can be dangerous and may cause severe damage to persons or property if subject to misuse.

NEVER allow anyone to operate this equipment unless they are thoroughly reliable and completely familiar with the safety precautions.

1. Never direct the spray jet at any person or animal.
2. Never hold a finger over the high pressure nozzle.
3. Never direct the spray jet at the machine itself or any other electrical equipment.
4. After use, and before disconnecting hoses, release the pressure in the high pressure hose by operating the trigger. Do not attempt to disconnect any hose or coupling with pressure still in the hose.
5. Never operate the machine with any of the covers removed.
6. Do not attempt any electrical or mechanical repair. If you have a problem with your machine contact your local dealer or Clarke **Customer Services Dept., tel: 020 8988 7400**
7. Never supply any liquid other than water to the water inlet.
8. Use only chemical cleaning agents (detergents) approved for power washing when using the chemical injection facility.
9. Never use the chemical injection facility to introduce solvents e.g., paint thinners, petrol, oil, etc.
10. Do not operate the machine whilst standing on ladders: use a platform tower or scaffolding.
11. Children should not be allowed to use the machine.
12. We recommend the use of safety goggles when using machine in any application where loose particles of stone or grit etc. may be blown around by the high pressure spray.
13. When not in use, disconnect from the water and electrical supply's, and ensure the system is completely drained. Store in a dry, frost free environment.

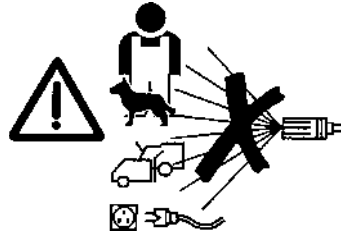

ACCESSORIES

A range of accessories designed for use with your washer are available from your Clarke dealer, as follows:

	Part No.
Rotary Brush	7310160
Water Sandblaster	7310161
Drain Cleaner	7310163
Heavy Duty Extension Hose (10M)	7310162
Traffic Film Remover 5 litre	3050821
Traffic Film Remover 25 litre	3050820
Wash 'n Wax 5 litre	3050815

PARTS and SERVICE CONTACTS

For Spare Parts and Service, please contact your nearest dealer, or CLARKE International, on one of the following numbers.

PARTS & SERVICE TEL: 020 8988 7400

or e-mail as follows:

PARTS: Parts@clarkeinternational.com

SERVICE: Service@clarkeinternational.com

TROUBLE SHOOTING

FAULT	CAUSE	REMEDY
Pressure drop	Air in system Worn high pressure nozzle. Pressure regulator incorrectly set	Bleed system by quickly switching off pistol grip several times. If necessary operate the machine briefly without the high pressure hose connected. Renew nozzle Push nozzle IN or OUT as req'd
Pressure fluctuations or pressure drop	No water Water supply hose too long/ too small diameter No water due to clogged filter	Turn on water tap Use minimum 1/2" dia. water supply hose Clean water filter (never operate without filter)
Oil leakage	Worn seals	Contact your CLARKE distributor
Motor does not start when switched on	Plug is not connected properly. Mains fuse blown/switched off	Check plug and lead and have them replaced by a qualified electrician if necessary Rectify
Motor hums when switched on and does not start	Mains voltage too low Incorrect dia. cable. Trigger Switch not operated	Have electrical conns. checked Use correct diameter of cable Operate trigger
Motor cuts out	Machine overheating Overheating-Thermal Overload activated Nozzle clogged	See Heating Overload Ensure supply voltage and unit voltage are equal. See Motor Thermal Overload Clean using the supplied nozzle cleaning needle
Additives are not being supplied	Injector clogged Additive container empty Lance not correctly set	Clean Fill additive container Set the lance to low pressure by pulling the nozzle out
Motor operates but no hot water	Fuse blown	Replace 1 amp fuse (see page 13) If problem persists, contact your Clarke dealer.

Should the machine fail to operate, despite carrying out the above procedures, it is probable that it requires servicing. Please contact your Clarke dealer.

Clarke
INTERNATIONAL

14. Disconnect from the mains supply before carrying out any maintenance or servicing.
15. Never pull the washer by the power cable, or yank the cable to disconnect from the socket. Keep the cable away from heat, oil or sharp edges.
16. Observe all precautions regarding the use of flammable liquids when filling the fuel tank.
17. Take care when handling the lance when hot washing. The metal components can become very hot. It is strongly advised that a good pair of industrial gloves be worn.
18. DO NOT operate the machine indoors or in enclosed areas without adequate ventilation, or in areas where flammable vapours (Petrol, solvents etc.), may be present.
19. This machine MUST be connected to the mains supply via a Residual Current Device (RCD)



IMPORTANT:

If the machine must be used in an enclosed area, ensure the burner exhaust is vented to the outside atmosphere.
All venting must be in accordance with applicable laws and local ordinances for such installations.

Clarke
INTERNATIONAL

ELECTRICAL CONNECTIONS

WARNING: THIS MACHINE MUST BE EARTHED.

This product is provided with a standard 13 amp, 230 volt (50Hz), BS 1363 plug, for connection to a standard, domestic electrical supply.

Should the plug need changing at any time, ensure that a plug of identical specification is used. **IMPORTANT:** The wires in the mains lead should be wired up in accordance with the following colour code:

Green & Yellow Earth
 Blue Neutral
 Brown Live

As the colours of the wires in the mains lead may not correspond with the coloured markings identifying the terminals in your plug, proceed as follows:

Connect GREEN & YELLOW coloured cord to plug terminal marked with a letter "E" or Earth symbol "⏏".

Connect BROWN coloured cord to plug terminal marked letter "L"

Connect BLUE coloured cord to plug terminal marked letter "N"

This machine must be connected to the mains supply through a Residual Current Device (RCD).

FUSE RATING

The fuse in the plug must be ASTA approved to BS1362 and rated at **13 amps**

IMPORTANT:

If this appliance is fitted with a plug which is moulded onto the electric cable (i.e. non-rewireable) :

1. The plug must be thrown away if it is cut from the electric cable. There is a danger of electric shock if it is subsequently inserted into a socket outlet.
2. Never use the plug without the fuse cover fitted.
3. Should you wish to replace a detachable fuse carrier, ensure that the correct replacement is used (as indicated by marking or colour code).
4. Replacement fuse covers can be obtained from your local dealer or most electrical stockists.

EXTENSION CABLES

If an extension cable is used, always ensure it is fully unwound. When used outdoors, ensure the extension cable is specifically designed for outdoor use.

The maximum extension length is 25 metres. Ensure that the wire sizes in the cable are at least 2.5mm² in cross section. As a general rule, the extension cable must be thicker than the cable supplied with the washer.

**IF IN DOUBT, CONSULT A QUALIFIED ELECTRICIAN.
 Do not attempt any electrical repairs yourself.**

PARTS LIST

No.	Description	Part No.
1	Cover	MPVR36616
2	Red Cover	MPVR46081
3	Wheel Pin	LAFN36486
4	Wheel	RTRT28559
5	Washer	VTRS28558
6	Hub Cap	MPVR46574
7	Bracket	LAFN36487
7	Bracket	LAFN36488
8	Handle	LAFN47234
9	Fuel Tank	MPVR26981
10	Tank Cap	MPVR28928
11	Control Box	MPVR26978
12	Joint	GUGO11309
13	Box Cover	MPVR26979
14	Label	ETET45910
15	Gasket	GUGO27464
16	Switch	MEC127900
18	Cable Fastener	MEVR20906
19	Cable Clamp	MPVR27097
20	Pressure Switch	MEPF28907
21	L.P. Hose	TBBP00058
22	L.P. Hose	TBBP04917
23	Filter	FTDT04648
24	1ph Motor	MOMO31013
25	O-ring	GUGO21339
26	Bushing	RCDS21487
27	O-ring	GUGO21637
28	Pump	PPAP21233
29	Cap	RCDS12676
30	Pressure Gauge	MNMN37538
33	Hose-fitting	TBAP27463
34	Elbow	RCVR00574
35	Tube	LAFN27460
36	Male Coupling	RCIN03753
37	Tube	MPLV27860
38	Nipple	RCDS27659
39	Filter	FTAC09717
40	Gasket	GUGO21889
41	Hose Fitting	RCDS23474
42	Connector	RCDS23628
43	H.P. Hose	TBAP20264
44	Lance	IPPR43857
45	Lance Extension	LCPR43860

PARTS DIAGRAM

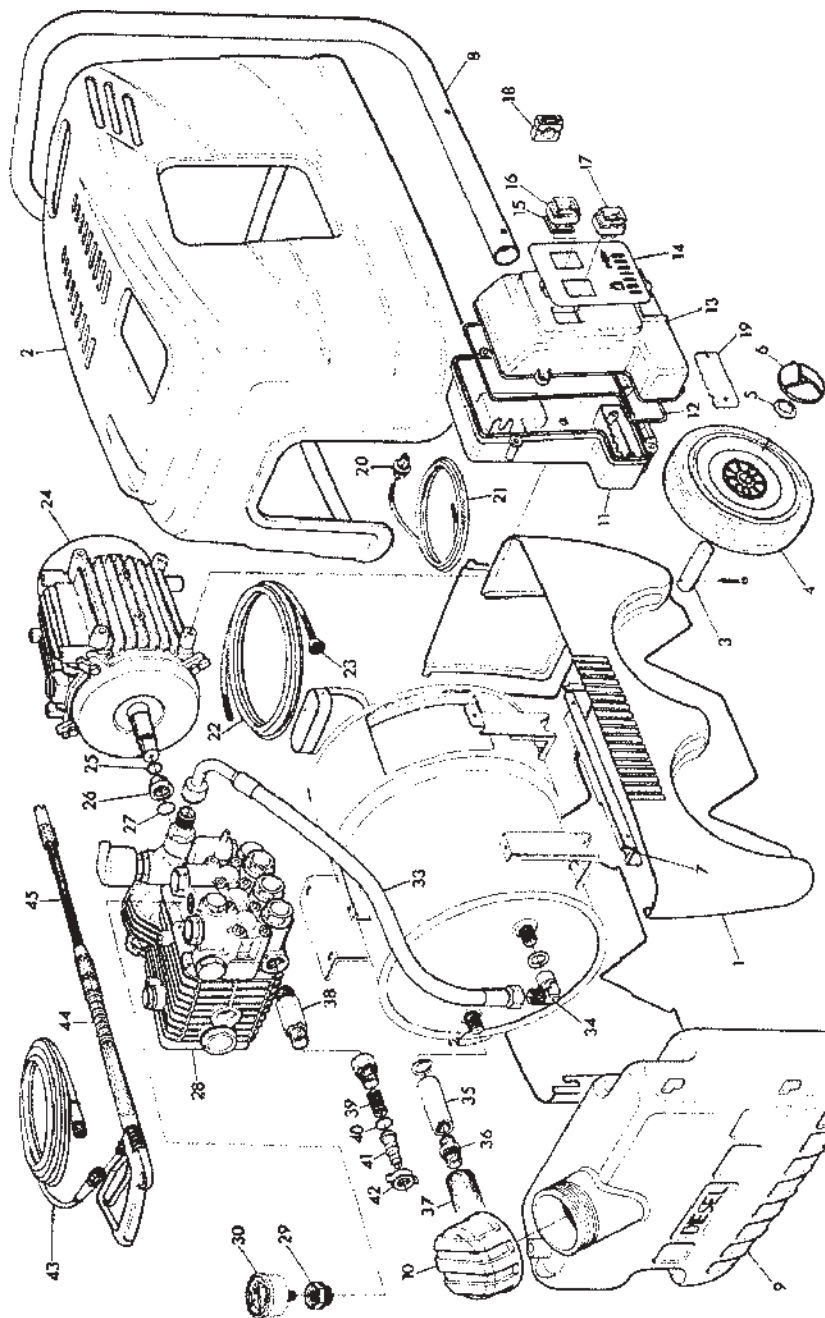

ASSEMBLY AND PREPARATION FOR USE

Firstly assemble the hose bracket to the frame using the 4 screws and nuts provided.

The Lance

1. The lance is assembled by screwing the two sections together.
2. Remove the travel plug from the outlet port, at the front of the machine (A Fig.2), and screw on the high pressure hose, then connect the other end to the lance (Fig.2A).

Tighten the connections, but take care not to overtighten.

Finally, slide the shroud up, and over the screw connection on the lance, firmly.

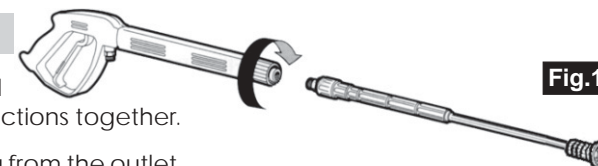

Fig.1.

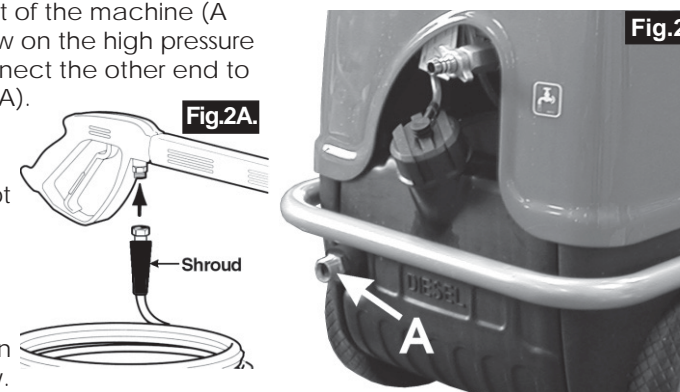

Fig.2.

Fig.2A.

Water Supply

A 3/4" BSP adapter with a 1/2" hose connector is provided at the low pressure water inlet, shown at B, Fig.3. Screw it on to the water inlet, ensuring the plastic washer provided is inserted.

A suitable hose with a MINIMUM inside diameter of 1/2" (not supplied), may be attached, with a worm drive clip (not supplied), and connected to your water supply. Alternatively, quick fit couplings, which are readily available from most hardware or DIY stores, may be used.

Turn on the water supply, and check for leaks. Rectify if necessary.

CAUTION.

The water inlet connection is directly above the diesel fuel filler cap. Ensure the connection is completely leak free, otherwise there is a possibility of fuel contamination should the filler cap be inadvertently loose, or dislodged.

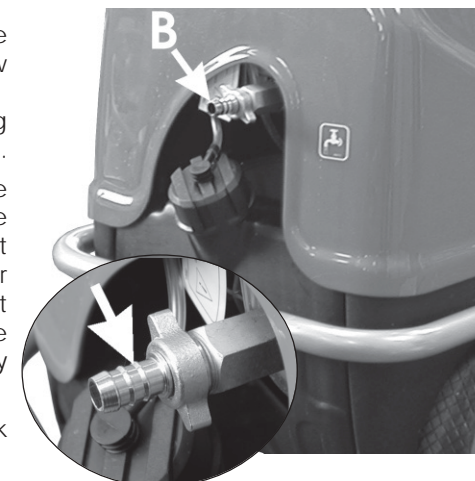

Fig.3.

IMPORTANT:

Before use, ensure the water supply is of adequate volume for your needs, e.g., if you use a water butt - ensure it contains sufficient water.

Fuel

Unscrew the fuel filler cap (C, Fig.4), and fill the tank with diesel fuel using an appropriate size funnel.

WARNING: DO NOT USE PETROL

Detergents

If you intend to use the chemical injection facility, drop the end of the filter take-up hose, situated at the rear of the machine and which is fitted with a filter, into the detergent canister.

NOTE:

If the filter is loose, ensure it is attached to the end of the detergent pick-up hose before use.

Use ONLY those detergents specifically designed for use with Power Washers. We recommend the use of CLARKE Traffic Film Remover, which is a powerful low foaming agent for car cleaning, patio cleaning etc., or CLARKE Wash & Wax, both available from your CLARKE dealer.

Ensure the detergent is mixed according to the manufacturers instructions.

See 'Operation' for additional information regarding the use of detergents.

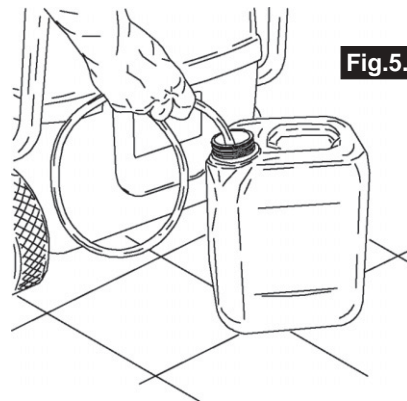

Dilute the detergent according to manufacturers instructions



MOTOR THERMAL OVERLOAD

Should the motor overheat, the motor thermal overload will intervene.

Allow at least three mins., then remove the main cover and press the reset button, located beneath the main ON/OFF switches, protected by a transparent cover, shown in Fig 18.

Whilst carrying out this operation, check the serviceability of the 1amp fuse, adjacent to the reset button.

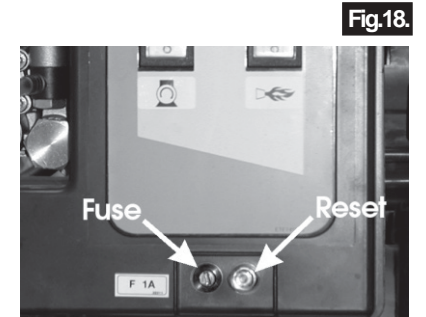

HEATING OVERLOAD

Should the machine overheat, the thermal overload will intervene.

Allow at least three mins. before removing the main cover, unscrewing the protective cap, on the side of the main junction box, arrowed in Fig 17, and pressing the reset button.

NOTE: The reset buttons will only activate once the temperatures reduce to a safe level. This should normally take 3 mins. or so, but could be longer depending upon circumstances. Should the machine still fail to start, following the reset procedures, then the problem is likely to be more serious. Contact your Clarke dealer

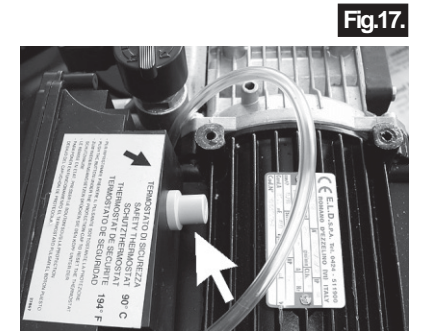

AFTER FIRST 50 HOURS OF USE.

Carry out the first oil change as follows:

- Remove top cover.
- Undo the oil drain plug 'C' Fig. 13.
- Unscrew and remove the dipstick 'B' Fig.13, then drain the oil from the pump.

Fig.14.

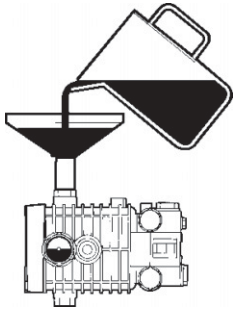

Replace the drain plug and fill with oil until the level is above the centre of the oil sight glass, shown at 'A' Fig.13 and in detail in Fig.15, or the middle of the cutout on the dipstick .

Subsequently, the oil should be changed every 500 hours of service.

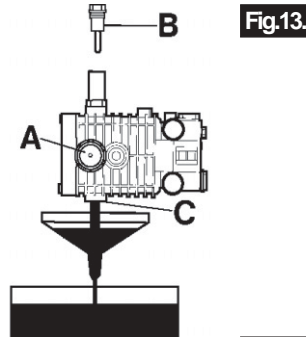

Fig.13.



Fig.15.

EVERY 50 HOURS

Clean water filter. Remove the water inlet hose adapter, and withdraw the filter. Clean thoroughly, or replace if badly contaminated or damaged in any way.

EVERY 100 HOURS

Clean the fuel filter. Disconnect from the fuel line using a pair of long nose pliers on the retaining clips, and clean thoroughly in clean diesel fuel. Ensure no foreign objects are present before reinstalling. If there are any signs of damage or if the filter is contaminated - replace it.

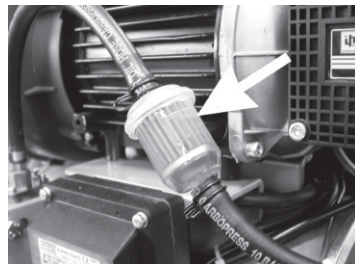

Fig.16.

EVERY 200 HOURS

It is necessary to have your washer serviced by authorised technicians to descale and clean the heating coil, clean the fuel pump, change the fuel nozzle, regulate the electrodes and calibrate and check the safety devices. Please contact your Clarke dealer.

OPERATION

A. COLD WASH

Make certain the PUMP ON/OFF switch mounted on the side of the unit, (see Fig.3), is set in the 'O' OFF position.

Connect the plug to the mains supply, preferably via a Residual Current Device. Turn the water tap fully on.

When starting, it is **IMPORTANT** that you adopt the following procedure:

In order to ease the starting process, and to prevent the possibility of blown fuses, pull the trigger on the lance - it may be necessary to release the safety latch ('S' Fig 6) in order to do so.

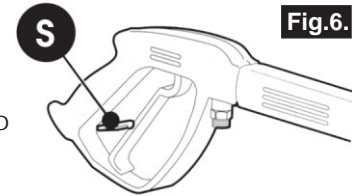

Fig.6.

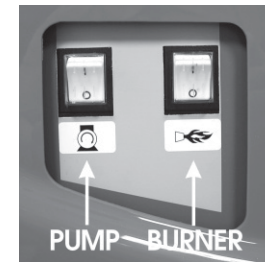



Fig.7.

Hold the trigger in that position whilst switching the pump switch, denoted by the symbol  to 'I' (ON), and allow the pump to develop full pressure. You may release the trigger once full pressure is developed.

WARNING

Ensure the operator is aware that when the trigger is pulled, water at high pressure can cause the lance to kick it should therefore be held firmly.

In addition, care must be taken to ensure that the nozzle is NOT aimed at an area where the water jet will cause damage. i.e. away from people, animals, windows - greenhouses etc., and be aware that splash back could also cause damage if the jet is trained on a nearby wall etc.

In the event that you switch the machine OFF but intend to continue with its use after a few minutes or so, DO NOT depress the trigger, but set the safety latch to prevent it from being pulled. This will ease and assist the subsequent restarting of the motor as pressure will remain equalised on either side of the pump, thereby reducing the load on the motor when restarting.

NEVER attempt to run the machine with the water supply disconnected or turned off.

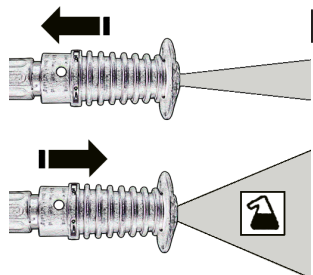

Fig.8.

HIGH and LOW PRESSURE is set by pulling IN or pushing OUT the nozzle as shown in Fig. 8.

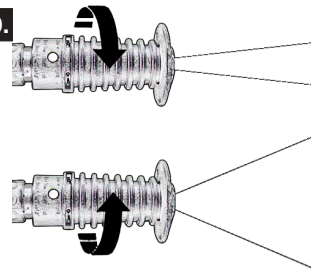

Fig.9.

IN -HIGH pressure OUT - LOW pressure

Additionally a FAN SPRAY may be used by twisting the nozzle as shown in Fig.9.

High pressure may also be regulated at the knob on top of the unit, shown at 'A' in Fig. 10. By turning clockwise the pressure is reduced. A scale alongside the knob 'B', registers the outlet pressure.

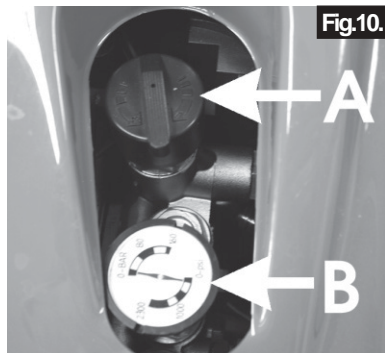



Fig.10.

USING DETERGENTS

Detergents will automatically be drawn and mixed with the water jet when the nozzle is set to LOW PRESSURE.

NOTE: The detergent facility will ONLY operate at LOW PRESSURE

B. HOT WASH

Follow the same procedure as for the cold wash, but switch the burner ON once the pump has been switched ON, by pressing the rocker switch on the side of the unit, denoted by the symbol  to 'I' (ON).

If the burner does not start or smoke issues from the exhaust, it is likely that the fuel system requires bleeding. To do this, first remove the top cover, ensuring the machine is disconnected from the mains supply, then open the bleed valve shown in Fig.11. When fuel is emitted, retighten the valve, and replace the top cover.

Take care when using the HOT WASH facility. DO NOT forget that certain components get extremely hot during operation, and will remain so for a period after switching OFF. This includes the metal parts of the lance.

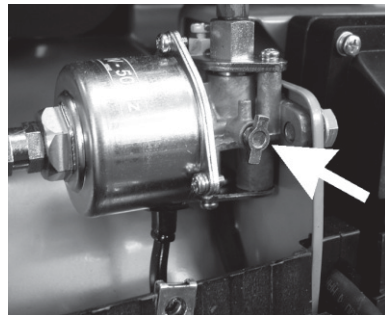

Fig.11.

C. SHUTTING DOWN THE MACHINE

If the burner has been used, switch it OFF FIRST by pressing the rocker switch, on the side of the unit, to 'O' (OFF).

Allow the pump to run for a minute or so until the water being ejected is cold then switch OFF the pump by pressing the switch to 'O' (OFF).

If the chemical injection facility has been used, set the lance to HIGH pressure, and allow the pump to run for a minute or so until the water being ejected is cold and foam free, then switch OFF the pump by pressing the switch to 'O' (OFF).

Disconnect from the mains electrical supply, and turn OFF the water supply - disconnect where appropriate.

Operate the lance trigger once more to ensure there is no pressure in the high pressure hose. NEVER disconnect High pressure hose without operating trigger.

MAINTENANCE

WARNING:

Ensure the machine is disconnected from the mains supply before carrying out any adjustment, servicing or maintenance.

AFTER EACH USE

When using chemical detergents, always ensure the system is thoroughly flushed out after use as described in 'Shutting Down The Machine' above.

Ensure the hoses and power cable are coiled and properly stowed. DO NOT allow them to be left casually, in a heap. This invites damage and will cause rapid deterioration. Take care NOT to drape the hoses/cables over the hot exhaust. Check to ensure they are fully serviceable.

STORAGE

Store the Hot Washer preferably under cover, protected from the elements.

If there is a danger of freezing, the pump should be filled with antifreeze by inserting the inlet and outlet hoses into a bucket of antifreeze as shown in Fig.10. Start the machine and allow the antifreeze to circulate. After a short time stop the machine using the procedure outlined above, and store the machine with the antifreeze still within the pump body.

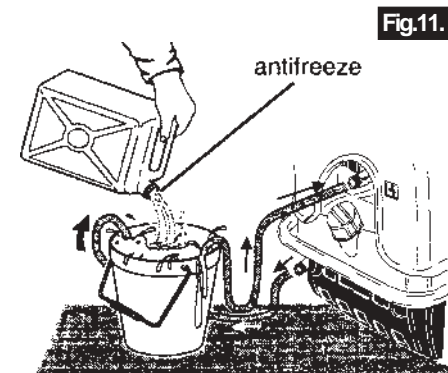

Fig.11.