

A SELECTION FROM THE VAST RANGE OF

# Clarke<sup>®</sup>

QUALITY PRODUCTS

#### AIR COMPRESSORS

From DIY to industrial. Plus air tools, spray guns and accessories.

#### GENERATORS

Prime duty or emergency standby for business, home and leisure.

#### POWER WASHERS

Hot and cold, electric and engine driven - we have what you need.

#### WELDERS

Mig, Arc, Tig and Spot. From DIY to auto/industrial.

#### METALWORKING

Drills, grinders and saws for DIY and professional use.

#### WOODWORKING

Saws, sanders, lathes, mortisers and dust extraction.

#### HYDRAULICS

Cranes, body repair kits, transmission jacks for all types of workshop use.

#### WATER PUMPS

Submersible, electric and engine driven for DIY, agriculture and industry.

#### POWER TOOLS

Angle grinders, cordless drill sets, saws and sanders.

#### STARTER/CHARGERS

All sizes for car & commercial use.



# Clarke<sup>™</sup>



0303

## 40 Piece Rotary Tool Kit

Model No. CRT 40

**Clarke** INTERNATIONAL

For spare parts and servicing, please contact your nearest dealer, or Clarke International on

**020 - 8988 - 7400**

e-mail: [Parts@clarkeinternational.com](mailto:Parts@clarkeinternational.com) e-mail: [Service@clarkeinternational.com](mailto:Service@clarkeinternational.com)

## Users Instructions



## GUARANTEE

This CLARKE product is guaranteed against faulty manufacture for a period of 12 months from the date of purchase. Please keep your receipt as proof of purchase.

This guarantee is invalid if the product is found to have been abused or tampered with in any way, or not used for the purpose for which it was intended.

Faulty goods should be returned to their place of purchase, no product can be returned to us without prior permission.

This guarantee does not effect your statutory rights.

## TECHNICAL SPECIFICATIONS

Voltage .....	230V 50Hz 1ph
Power Rating .....	135W
No Load Speed .....	15,000 - 35,000RPM
Collet Capacity .....	1/8"
Weight .....	2.5kg (packed)
Model No. ....	CRT40
Part No. ....	6462001

Please note that the details and specifications contained herein, are correct at the time of going to print. However, CLARKE International reserve the right to change specifications at any time without prior notice.

## SPARE PARTS AND SERVICE CONTACTS

For Spare Parts and Service, please contact your nearest dealer, or CLARKE International, on one of the following numbers.

**PARTS & SERVICE TEL: 020 8988 7400**

**PARTS & SERVICE FAX: 020 8558 3622**

or e-mail as follows:

**PARTS: [Parts@clarkeinternational.com](mailto:Parts@clarkeinternational.com)**

**SERVICE: [Service@clarkeinternational.com](mailto:Service@clarkeinternational.com)**

## PARTS LIST

No.	Description	Part No.
1	Head Cap .....	TMCT4001
2	Push Button .....	TMCT4002
3	Housing .....	TMCT4003
5	Step Pin .....	TMCT4005
6	Spring Ring .....	TMCT4006
7	Hex Nut .....	TMCT4007
8	Collet .....	TMCT4008
9	Clip Ring .....	TMCT4009
10	Ball Bearing .....	TMCT4010
11	Cooling Fan .....	TMCT4011
12	Armature .....	TMCT4012
13	Ball Bearing .....	TMCT4013
14	Stator .....	TMCT4014
15	Brush Copper Sleeve .....	TMCT4015
16	Brush Holder .....	TMCT4016
17	Carbon Brush .....	TMCT4017
18	Brush Cap .....	TMCT4018
19	PCB .....	TMCT4019
20	Housing .....	TMCT4020
21	Switch .....	TMCT4021
22	Hook .....	TMCT4022
23	Cable Anchorage .....	TMCT4023
24	Screw .....	TMCT4024
25	Cable Sleeve .....	TMCT4025
26	Plug & Cable .....	TMCT4026



## PARTS DIAGRAM

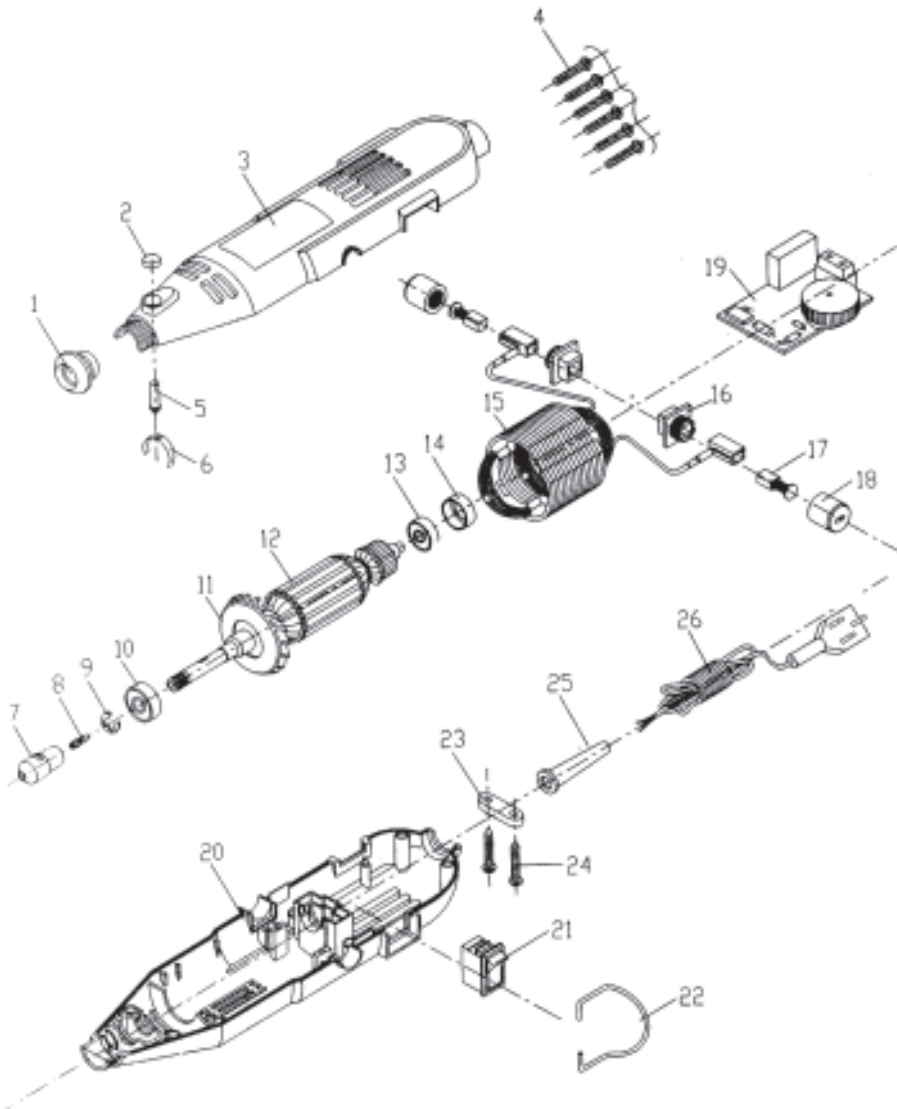

Thank you for purchasing this CLARKE 40 piece Rotary Tool Kit

Please read this leaflet thoroughly and follow the instructions carefully, in doing so you will ensure the safety of yourself and that of others around you, and you can look forward to the tool giving you long and satisfactory service.

## PACKAGE CONTENTS

The package contains:

- 1 Rotary Tool
- 1 Flexible Drive
- 1 Tool Stand Complete
- 1 Chuck spanner
- 40 Accessories/consumables
- 1 Case

## SAFETY PRECAUTIONS

- **ALWAYS** keep the power cable away from the moving parts of the rotary tool.
- **ALWAYS** switch off the tool and allow to stop fully before putting to one side.
- In the event of power failure or disconnection of supply for whatever reason, when the tool is in operation...**ALWAYS SWITCH OFF** the tool before putting down, then disconnect from the mains supply.
- **ALWAYS** ensure the accessories used are rated to rotate at, AT LEAST the maximum speed of the tool.
- **NEVER** attach an assembly wrench to your rotary tool with a piece of string or anything similar.
- **NEVER** press the drive shaft locking button when the rotary tool is operating.
- **ALWAYS** ensure that the mandrel diameter is the same as the collet diameter.
- **ALWAYS** use a clamping device for securing the work piece. Keep your hands away from the work piece.
- **ALWAYS** wear safety goggles, manufactured to the latest European Safety Standards. Everyday eyeglasses do not have impact resistant lenses, they are not safety glasses.
- **NEVER** force the tool, only light pressure is required to perform a task.
- **NEVER** overtighten the screw when mounting a grinding disc or cutting disc on to its mandrel.
- **NEVER** allow children to operate this tool.
- IF the tool begins to vibrate during operation, switch OFF immediately and investigate the cause.

## ELECTRICAL CONNECTIONS



This product is provided with a standard 13 amp, 230 volt (50Hz), BS 1363 plug, for connection to a standard, domestic electrical supply. Should the plug need changing at any time, ensure that a plug of identical specification is used.



*This appliance is Double Insulated, and the two wires in the mains lead should be wired in accordance with the following colour code:*

BLUE - NEUTRAL

BROWN - LIVE

- Connect the BLUE coloured cord to the plug terminal marked with the letter "N"
- Connect the BROWN coloured cord to the plug terminal marked with the letter "L"

If this appliance is fitted with a plug which is moulded on to the electric cable (i.e. non-rewireable) please note:

1. The plug must be thrown away if it is cut from the electric cable. There is a danger of electric shock if it is subsequently inserted into a socket outlet.
2. Never use the plug without the fuse cover fitted.
3. Should you wish to replace a detachable fuse carrier, ensure that the correct replacement is used (as indicated by marking or colour code).
4. Replacement fuse covers can be obtained from your local Clarke dealer or most electrical stockists.

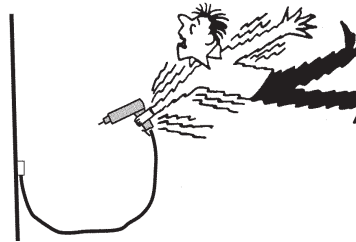

### FUSE RATING

The fuse in the plug must be replaced with one of the same rating (**5 amps**) and this replacement must be ASTA approved to BS1362.

If in doubt, consult a qualified electrician. Do not attempt any electrical repairs yourself.

### CABLE EXTENSION.

Always use an approved cable extension suitable for the power rating of this tool (see specifications), the conductor size should also be at least the same size as that on the machine, or larger. When using a cable reel, always unwind the cable completely.

**Clarke**  
INTERNATIONAL

## VARIABLE SPEED CHART

Speed Indicator Position	RPM
1	17,500
2	18,500
3	24,500
4	27,800
5	31,000
6	33,500

## MAINTENANCE

ALWAYS unplug the tool from the mains supply and ensure it is switched OFF when performing maintenance tasks.

The tool should be kept clean at all times, Ensure the ventilation ducts are clear, and the power cable is in good condition. Get into the habit of cleaning thoroughly after each use and before storing.

Never clean with solvents, use a moist cloth with soapy water if necessary.

The tool does not require lubrication.

## ACCESSORIES

A 100 piece Accessory Kit is available from your Clarke dealer.

Please quote Part Number 6468025

**Clarke**  
INTERNATIONAL

### 3. Sanding Band & Discs

Material	Speed
Wood	6
Steel	1
Aluminium, Brass	3
Plastic	1

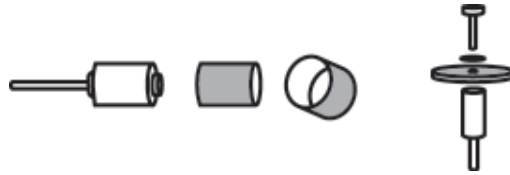

### 4. Stainless Steel Brushes & Bristle Brush

Material	Speed
Stone, Shell	2
Aluminium, Brass	2



### 5. High Speed Cutter, Diamond Wheel & Drill

Material	Speed
Stone, Shell	Max
Steel	3
Aluminium, Brass	6
Plastic	1

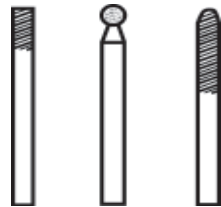

### 5. Abrasive Disc

Material	Speed
Stone, Shell	Max
Steel	3
Aluminium, Brass	6
Plastic	1

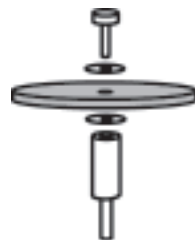

## ASSEMBLY OF COMPONENTS

### 1. Stand for the Rotary Tool

Screw the telescopic tube into the bracket and tighten. .

Clamp the bracket to a workbench or worktop with a maximum thickness at 2-1/8".

Slacken the top tube by turning the black knob anticlockwise (-). Draw the tube out to its maximum height and secure it by turning the knob clockwise (+).

Turn the middle tube anticlockwise (-) and extend as required. Lock in position by turning the tube clockwise (+)

The Rotary Tool may now be supported by the suspension bracket of the stand as shown. (this suspension bracket can be turned 360°).

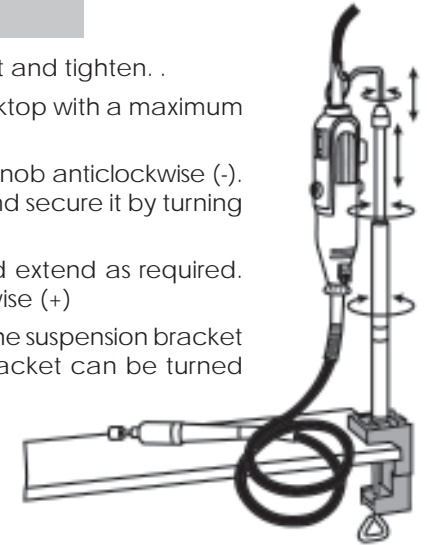

### 2. Assembling Accessories to the Tool

**IMPORTANT:** Ensure the tool is switched OFF at the mains supply and at the tool.

- Press down on the drive shaft locking button (2), and hold down.
- Undo the chuck (1) using the spanner provided.
- insert the mandrel of the tool to be used in to the chuck FULLY, and tighten the chuck.

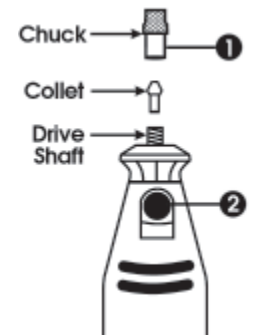

### 3. Assembling Abrasive Discs & Grinding Stones to Mandrel

- Mount the selected disc on to the mandrel as shown, ensuring the two washers are in place. DO NOT overtighten the screw

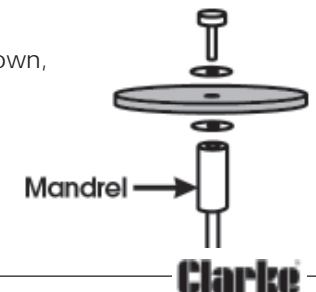

## 4. Assembling Polishing Bob

- Screw the Bob on to the mandrel firmly, but do not overdo it.

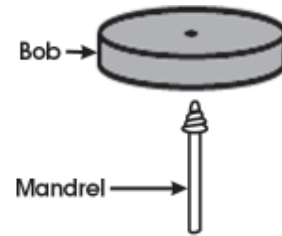

## 5. Assembling Abrasive Bands

- Slacken the screw on the end of the Mandrel, and slide the appropriate abrasive band on to the rubber former, fully.
- Tighten the screw to secure the band to the former.

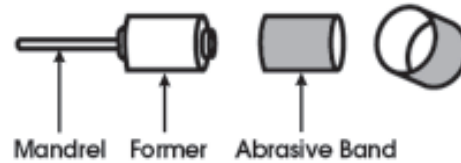

## 6. Attaching the Flexible Drive Assembly

- Unscrew and remove the Securing Ring (3) and retain.
- Slacken the chuck using the spanner provided, by pressing and holding the locking button (5).
- Slide the flexible drive through the chuck and into the collet, **FULLY**.
- Hold back the Securing ring (3), whilst tightening the chuck, thereby securing the flexible drive.
- Screw the Securing Ring (3) on to the end of the tool, **taking GREAT CARE to ensure you do not cross thread it**.
- At the opposite end of the Flexible Drive, insert the mandrel of the tool to be used, into the chuck.

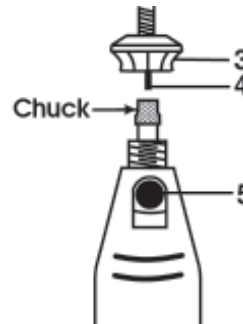

To undo the chuck, pull back on the sleeve, in the direction of the arrow, and hold back, to lock the chuck so that the spanner may be used.

Insert the mandrel, fully, then retighten the chuck.

Release the sleeve to release the chuck.



## OPERATION

Assemble the tool as described previously.

Holding the tool firmly, and ensuring your fingers are well away from the rotating parts, plug into the mains and switch ON by pressing 'I' (A).

Adjust the speed according to the job in hand, by turning the adjuster 'B', using the tables below for reference.

To switch OFF, press 'O' (A).

**⚠ CAUTION! NEVER put the tool down until it has stopped completely.**

DO NOT use force when using this tool, a light pressure is all that is required.

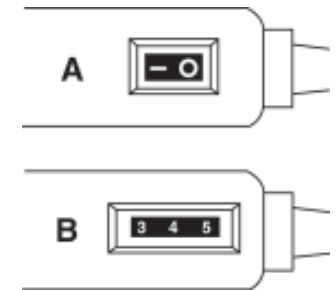

## REFERENCE TABLES

- The following speeds are for guidance only.
- DO NOT force the tool, apply a light pressure only.
- ALWAYS wear safety goggles.

### 1. Grinding Stones

Material	Speed
Stone, Shell	1
Steel	5
Aluminium, Brass	2
Plastic	1



### 2. Polishing Bob

Material	Speed
Steel	5
Aluminium, Brass	3
Plastic	5

