

CLARKE®

POWER



WARNING: Do not use the generator without reading this manual

INVERTER GENERATOR

MODEL NO: IG2000D

PART NO: 8877116

OPERATION & MAINTENANCE INSTRUCTIONS

UK
RA | CE



ORIGINAL INSTRUCTIONS

DL0922 REV 1

INTRODUCTION

Before you use this product, read this manual and follow the instructions carefully. In doing so you will ensure the safety of yourself and others around you, and you can also expect your purchase to give you a long and satisfactory service.

GUARANTEE

This product is guaranteed against faulty manufacture for a period of 12 months from the date of purchase. Please keep your receipt which will be required as proof of purchase.

This guarantee is invalid if the product is tampered with in any way, or not used for the purpose for which it was intended.

Faulty goods should be returned to their place of purchase, no product can be returned to us without prior permission. This guarantee does not effect your statutory rights.

ENVIRONMENTAL PROTECTION



Recycle unwanted materials instead of disposing of them as waste. All tools, accessories and packaging should be sorted and taken to a recycling centre for disposed in a manner compatible with the environment.

By purchasing this product, the customer is taking on the obligation to deal with its safe disposal in accordance with the Waste Electrical and Electronic Equipment (WEEE).

In effect, this means that this product must not be disposed of with general household waste. It must be disposed of according to the laws governing Waste Electrical and Electronic Equipment (WEEE) at a recognised disposal facility. If disposing of this product or any damaged components, do not dispose of with general waste. This product contains valuable raw materials. Metal products should be taken to your local civic amenity site for recycling of metal products.

GENERAL SAFETY RULES



WARNING: EXHAUST FUMES CAN BE EXTREMELY DANGEROUS IF INHALED

WORK AREA

- **ALWAYS** use in a well ventilated area.
- **ALWAYS** position the exhaust outlet away from people.
- Read these safety instructions before using the equipment.
- Keep children away from the generator.

POSITIONING THE GENERATOR

1. Keep the generator at least 1 m (3 ft.) from buildings or other equipment, or the engine may overheat.
2. Place the generator on a solid, flat surface.
3. Make sure the surrounding area is free from any material that could burn or be damaged by heat.
4. **NEVER** move or tilt the generator whilst it is switched on.

FIRE PREVENTION

1. **ALWAYS** switch the engine OFF when refuelling.
2. **ALWAYS** refuel in a well ventilated area.
3. **NEVER** overfill the tank, only fill to the level specified.
4. **NEVER** smoke whilst refuelling and avoid smoking or using a naked flame near the generator.
5. **NEVER** start the engine if there is spilled fuel. Any spillage must be wiped clean and the generator allowed to dry before attempting to start the engine.

PREVENTION OF ELECTRIC SHOCK

1. **NEVER** use the generator in wet conditions unless it is well protected/ covered. Under these conditions, adequate ventilation **MUST** be provided.
2. **NEVER** operate the generator with wet hands.
3. **NEVER** use water or any other liquids to clean the generator.









4. Make sure you ground (earth) the generator.

ADDITIONAL SAFETY RULES FOR GENERATORS

1. **ALWAYS** make sure the applied load does not exceed the generator rating. Overloading the generator is dangerous and could cause serious damage.
2. **ALWAYS** disconnect the generator when carrying out any maintenance.
3. **ALWAYS** allow the generator to reach operating speed before connecting a load.
4. **NEVER** allow the generator to run out of fuel when a load is connected.
5. **NEVER** transport the generator with fuel in the tank.
6. **NEVER** connect the generator to a commercial or residential power supply; e.g. ring main.
7. **NEVER** allow the generator air vents to become blocked.

SAFETY SYMBOLS

The following safety symbols are shown on the product or it's packaging. Please read all of the safety and operating instructions carefully before using this product.

	Read instruction manual before use.		Hot surface - Do not touch
	Dangerous Voltage		Poisonous fumes - Do not use the generator in an enclosed space.
	Flammable		Caution - The user should be aware of a general hazard.
	Poisonous fumes- do not use the generator in an enclosed space.		This product produces high noise levels during operation. Ear protection is advised.

GENERATOR OVERVIEW - TBA

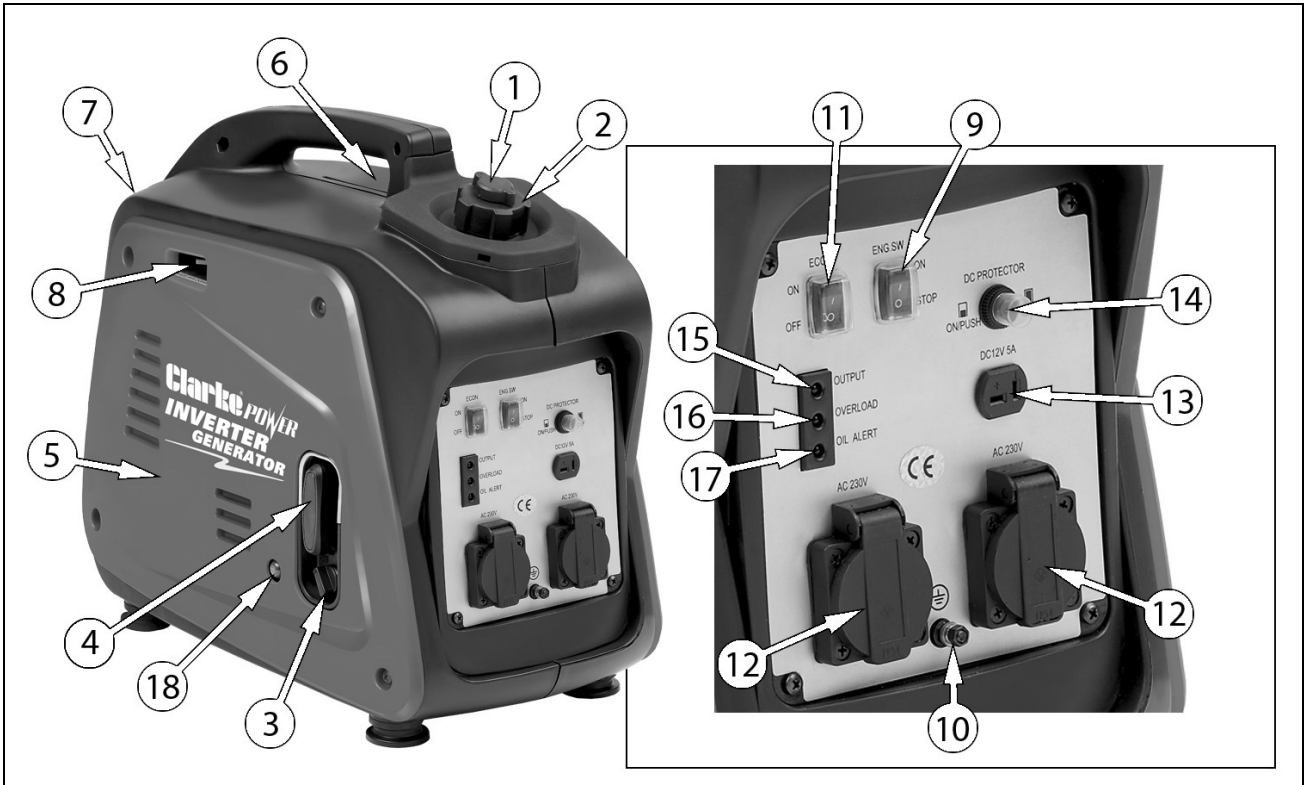

NO	DESCRIPTION	NO	DESCRIPTION
1	Air Vent Knob	10	Earthing Point
2	Fuel Cap	11	Economy Control Switch
3	Fuel Valve Knob	12	AC Socket
4	Starting Handle	13	DC Socket
5	Side Maintenance Cover	14	DC Circuit Breaker
6	Top Maintenance Cover	15	Output Indicator
7	Muffler	16	Overload Indicator
8	Choke	17	Oil Alarm Indicator
9	Engine ON/OFF Switch	18	Primer Bulb

After removing the generator from its packaging, check that it has not been damaged in transit. Report any damage immediately to the dealer where the item was purchased.

UNPACKING AND ASSEMBLY

Unpack your generator and check the following items are present. Should there be any missing or damaged during transit contact your CLARKE dealer.

1 x 1800 Watt Inverter Generator	1 x 12 Volt Connecting Lead Assembly
1 x Spark Plug Box Spanner	1 x Instruction manual
1 x Cross-head Screwdriver	

BEFORE USING THE GENERATOR

IMPORTANT: Generators should ALWAYS be earthed. Make sure you earth the generator.

Before using your generator check that:

- The generator is in good condition and free from any damage.
- The generator is clean and free from fuel or oil spillage.
- The generator is correctly located for use (see page 3).
- There is no leakage.

NOTE: To avoid accidental spillage of fuel, always use a funnel to fill the fuel tank. If fuel is spilled it must be removed from the unit before attempting to start the engine.

EARTHING



WARNING: IT IS ADVISABLE TO PROPERLY EARTH YOUR GENERATOR BEFORE STARTING USING A WIRE AND A SMALL METAL EARTH SPIKE. THE WIRE AND EARTH SPIKE ARE NOT SUPPLIED WITH THE UNIT.

An earth spike and cable can be purchased at your local camping supplier, or alternatively an earth spike can be made, and it is suggested you get advice from a qualified electrician.

To make a spike use a copper tube or copper rod 12mm diameter, a minimum length of 200mm and with an M6 machine screw one end.

The cable used should be a maximum length of 1 metre and a minimum of 1.0mm² to carry a 10amp load.

Attach the cable to the generator at the earth point (shown on the right).

Connect the other end to the spike between a flat washer and the copper rod with a lock washer under the head of the M6 machine screw in a similar fashion to the earth point screw on the generator.

When pushing the spike into the ground the generator must not be running and it is suggested that the spike is pushed into the ground by at least 100 mm.

Earthing of generators is covered in BS7430:2011. If you have any doubts about this subject consult a qualified electrician.

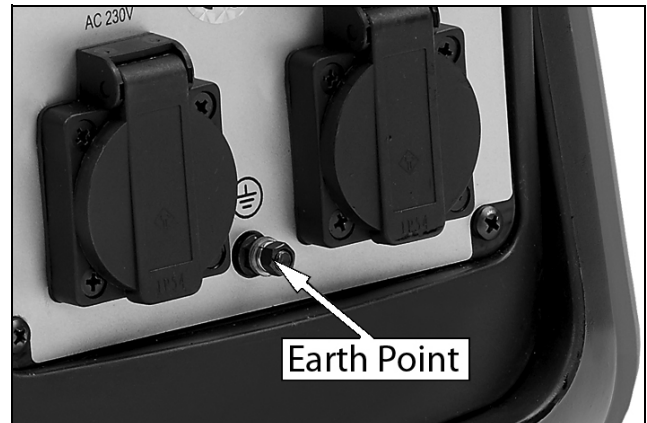

CHECKING THE AIR FILTER

1. Remove the side maintenance panel.



2. Remove the air filter cover screw shown on the right.
3. Slide out the air filter panel.

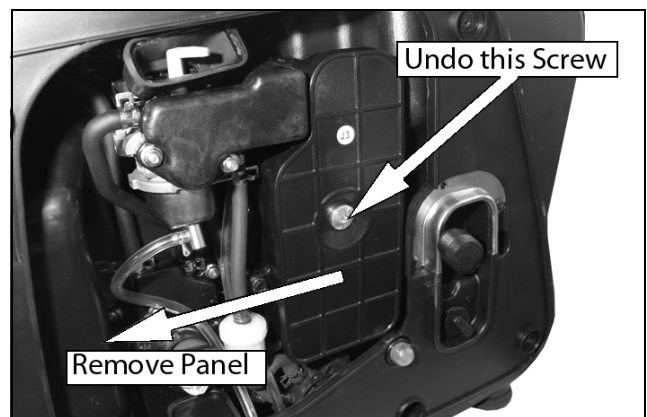

4. Remove the air filter element.
5. If the air filter is damaged contact the CLARKE spare parts department for a replacement.
 - If the filter is dirty, wash it in a solution of warm water and mild detergent and rinse thoroughly. Leave the filter to dry completely. Once it is dry immerse the filter in clean engine oil and squeeze the filter to remove excess oil.

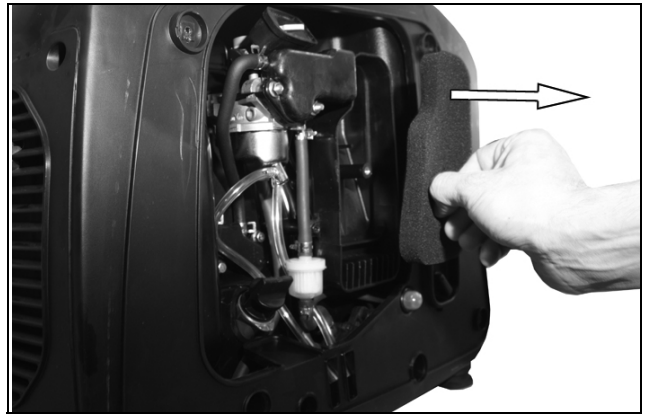

WARNING: DO NOT USE FLAMMABLE SOLVENTS OR PETROL TO CLEAN THE AIR FILTER.

6. Replace the filter into its original position and replace and secure the air filter cover then replace the side maintenance panel.

CHECKING THE ENGINE OIL LEVEL



WARNING: YOUR GENERATOR MAY NOT BE SUPPLIED WITH OIL. ALWAYS ENSURE THAT THERE IS SUFFICIENT OIL BEFORE USE.

WARNING: TO CARRY OUT THIS CHECK, THE ENGINE MUST BE OFF.

1. Place the generator on a level surface and check the oil level as follows.
2. Remove the side maintenance panel.



3. Turn the oil filler cap anti-clockwise and remove from the oil reservoir, wipe the dipstick with a clean cloth.

4. Insert the dipstick back into the oil filler tube and then remove it again.

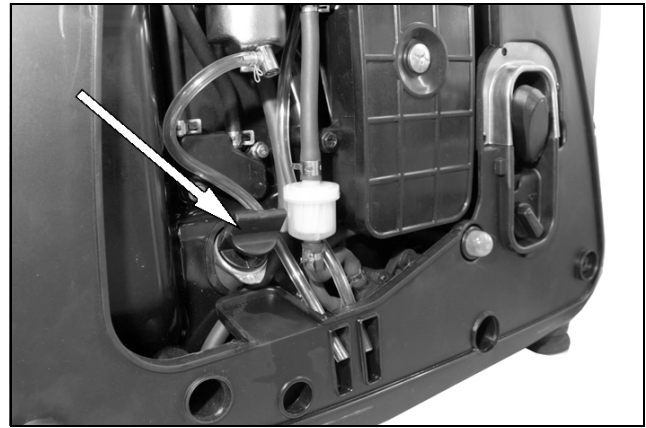

5. If the oil is below the Min. level on the dipstick, top up the oil reservoir with fresh oil.

- Do not fill above the max level mark (0.52 litres)
- We recommend the use of SAE30 oil in this generator. (CLARKE part number 3050852)
- Do not tilt the generator when adding engine oil. This could result in overfilling and damage to the engine.

6. Replace the oil filler cap.

7. Replace the left side maintenance panel.

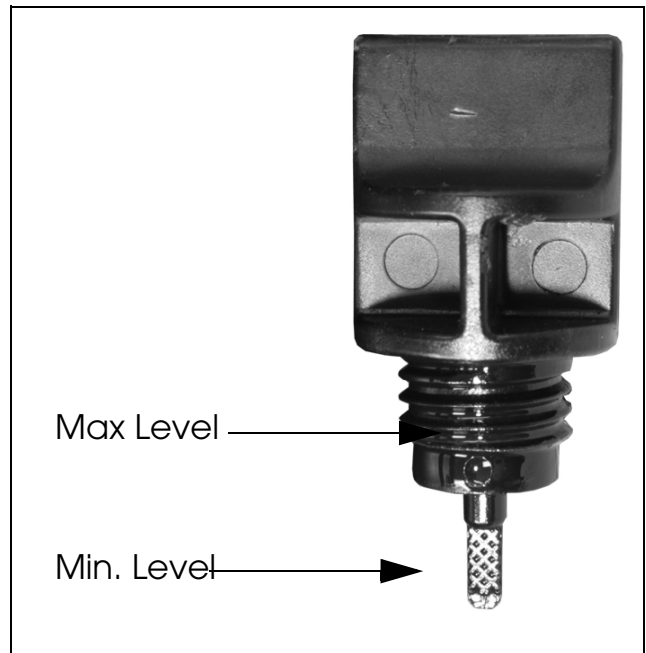

CHECK THE FUEL LEVEL



WARNING: MAKE SURE THERE IS FUEL IN THE TANK WHEN USING THE GENERATOR. RUNNING OUT OF FUEL OR STOPPING THE ENGINE SUDDENLY WITH A LOAD CONNECTED COULD CAUSE SERIOUS DAMAGE.

1. To check the fuel level, open the fuel filler cap.

2. Slowly add fuel to the fuel tank (maximum 4.1 litres)

- Do not overfill the fuel tank.

3. Replace the fuel filler cap securely.





WARNING: FUEL IS HIGHLY FLAMMABLE AND POISONOUS.

WARNING: SEE GENERAL SAFETY RULES ON PAGE 4 AND READ THEM CAREFULLY BEFORE REFUELING.

WARNING: DO NOT FILL ABOVE THE TOP OF THE FUEL FILTER OR IT MAY OVERFLOW WHEN THE FUEL HEATS UP AND EXPANDS.

WARNING: WIPE UP ANY SPILLED FUEL IMMEDIATELY.

WARNING: AFTER REFUELING, MAKE SURE THE FUEL FILLER CAP IS TIGHTENED SECURELY.

RECOMMENDED FUEL

Your generator has been designed to use regular unleaded petrol with an octane number of 86 or higher.

USING YOUR GENERATOR

STARTING THE ENGINE

1. Remove all connections from the AC sockets.
2. Hold the fuel tank cap so that it will not move, and turn the air vent knob to the 'open' position.
3. Turn fuel valve to the ON position (pointing right).

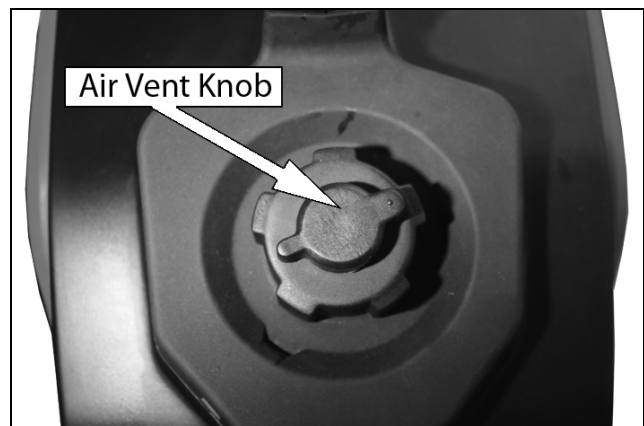

4. Set the engine switch to 'ON'.

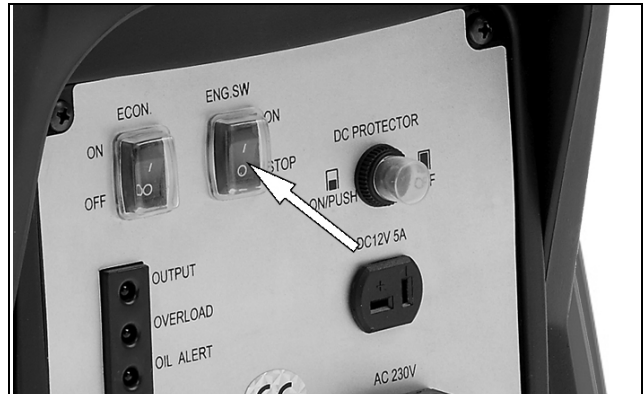

5. Move the choke lever to the right, to the 'Choke' position.



6. If this is the first time you are using the generator or if the generator had run out of fuel the last time you used it, pump the primer bulb a minimum of 6 times to introduce fuel into the carburettor.



7. Hold the generator handle firmly and pull the starting handle lightly until you start to feel resistance and then pull up sharply to start the engine.



NOTE: You may have to do this more than once.



WARNING: ONCE THE GENERATOR HAS STARTED, RELEASE THE STARTING HANDLE SLOWLY TO AVOID INJURY/DAMAGE AS IT WHIPS BACK.

NOTE: When you first start the generator, the overload indicator may light up for a few seconds, this is normal. If the overload indicator is still lit after 5 seconds, stop the engine and contact your CLARKE dealer.

8. Once the engine has warmed up, move the choke lever to the left, to the "run" position.

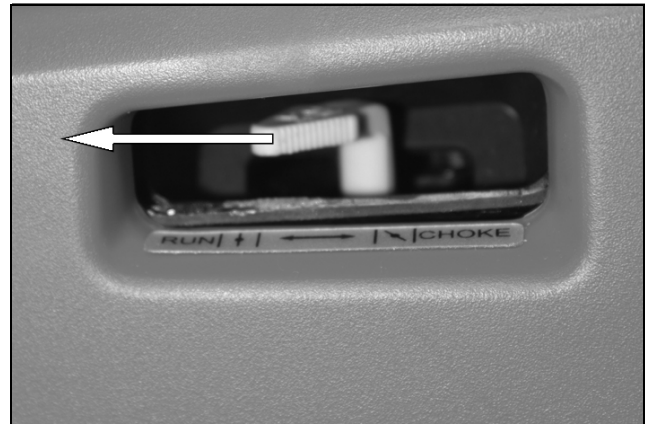

ECONOMY SWITCH

ON:

Recommended to minimize fuel consumption and further reduce noise levels when no load is applied to the generator. Engine speed varies with the load.

OFF:

The smart throttle system does not operate.



CAUTION: THE ECONOMY CONTROL DOES NOT WORK EFFECTIVELY IF THE ELECTRICAL APPLIANCE REQUIRES 'BURSTS' OF POWER.

CAUTION: TURN THE ECONOMY CONTROL FEATURE OFF WHEN CONNECTING HIGH LOAD APPLIANCES OR WHEN CONNECTING TO THE DC OUTPUT.

CONNECTING ELECTRICAL DEVICES

The generator can supply both 230V AC and 12V DC.

AC POWER

1. Start the engine. See pages 11-13.
2. Make sure the appliance is turned off before connecting it to the generator.
3. Connect the appliance (max load 1800W) to the generator.





CAUTION: MAKE SURE THAT THE APPLIANCE BEING CONNECTED IS IN GOOD WORKING ORDER, IF IT BEGINS TO ACT ABNORMALLY OR STOPS SUDDENLY, DISCONNECT IT FROM THE GENERATOR

CAUTION: MAKE SURE THE APPLIANCE DOES NOT EXCEED THE MAXIMUM RATED LOAD FOR THE GENERATOR.

CAUTION: ANY DEVICE WHICH CONTAINS AN INDUCTIVE LOAD E.G. DEVICES THAT CONTAIN A MOTOR MAY REQUIRE MORE CURRENT ON STARTUP.

DC POWER

1. Set the economy control switch to 'OFF'.
2. Start the generator. See page 10.
3. Make sure the appliance is turned off before connecting it to the generator.
4. Connect the 12V appliance(max 5A) to the generator.

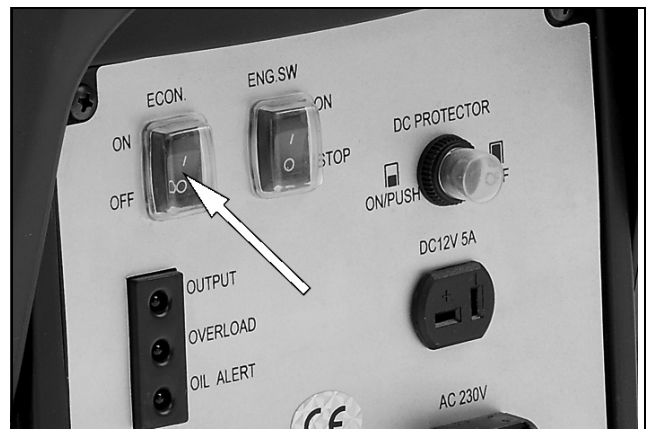

DC POWER (TOPPING UP CAR BATTERIES)



WARNING: FOR YOUR SAFETY PERFORM THE FOLLOWING INSTRUCTIONS IN THE ORDER SHOWN.

WARNING: YOU SHOULD ONLY USE THIS GENERATOR TO 'TOP UP' THE BATTERY, ALSO TRYING TO CHARGE A COMPLETELY FLAT BATTERY MAY CAUSE THE FUSE TO BLOW.

1. Set the economy control switch to 'OFF'.
2. Start the generator. See page 10.
3. Connect the battery charging leads to the battery.
 - Make sure you clamp the red wire to the positive (+) terminal and the black wire to the negative (-) terminal of the battery.
4. Connect the battery charging leads to the generator.



- The battery will begin to charge
5. Monitor the voltage across the battery regularly during charging and disconnect the battery when the voltage reaches 14.4 volts.



CAUTION: WHEN DISCONNECTING THE BATTERY, ALWAYS DISCONNECT THE NEGATIVE LEAD FIRST.

DC OVER LOAD PROTECTOR

If the DC overload protector activates, wait for a few minutes and then press the reset button shown on the right.



INDICATOR LIGHTS

OUTPUT

The output indicator (Green) will remain on during normal operation.

OVERLOAD

The overload indicator (Red) will light up if there is an overload or a short circuit in the connected appliance.

If this happens, proceed as follows:

1. Turn off any connected electrical devices and stop the engine.
2. Reduce the total wattage of connected electric devices to within the rated output of the generator.
3. Check air inlet and around the control unit. If any blockages are found, remove them.
4. After checking, restart the engine.



OIL ALERT

The oil alert indicator (Red) will light up when the oil level is low.

- To add oil, follow the instructions on page 11.

SHUTTING DOWN THE GENERATOR

To stop the generator in an emergency simply set the engine switch to 'OFF'.

NOTE: Turn off any electric devices.

NOTE: Set the economy control switch to the '0' (OFF) position.

1. Disconnect any electric devices.
2. Turn the fuel valve knob to "OFF" (pointing left).



3. Turn the air vent knob to the 'Close' position.

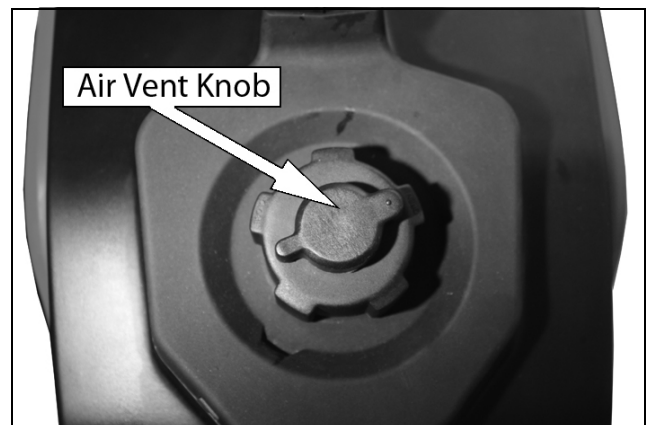

4. Set the engine switch to the "0" (OFF) position.



MAINTENANCE

ENGINE OIL (EVERY 20 HOURS OF USE)



CAUTION: PROLONGED EXPOSURE TO USED ENGINE OIL IS DANGEROUS, ALWAYS WASH YOUR HANDS THOROUGHLY AFTER HANDLING USED ENGINE OIL.

1. Remove the maintenance panel shown on the right.



2. Turn the oil filler cap anti-clockwise and remove from the oil tank.
3. Tilt the generator to allow the oil to drain out of the oil reservoir into a suitable container.

NOTE: You may need assistance with this step as the generator is heavy.

4. Fill the oil reservoir with fresh oil.
 - Do not fill above the max level mark (0.52 litres)
 - We recommend the use of SAE30 oil in this generator. (CLARKE part number 3050852)
5. Replace the oil filler cap and maintenance panel.

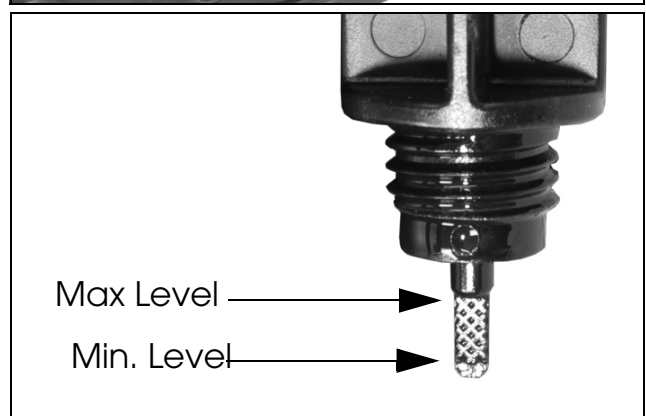
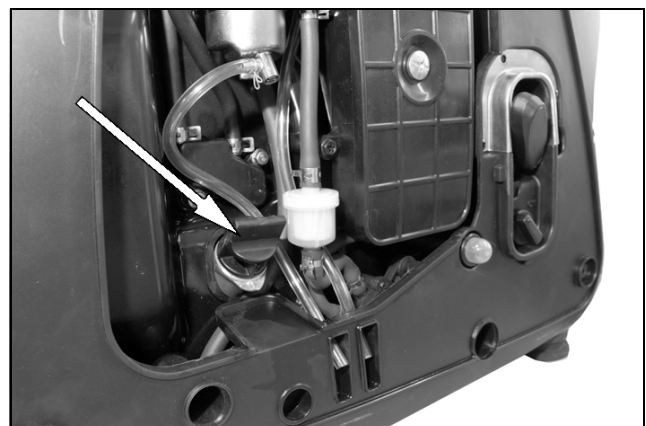

ENVIRONMENTAL PROTECTION

One of the most damaging sources of pollution is oil. Do not throw away used engine oil in with your domestic waste or down drains and sinks. Place it in a leak proof container and dispose of it according to local regulations.

AIR FILTER (EVERY 50 HOURS OF USE)

1. Remove the maintenance panel shown on the right.



2. Remove the air filter cover screw.
3. Remove the air filter panel.

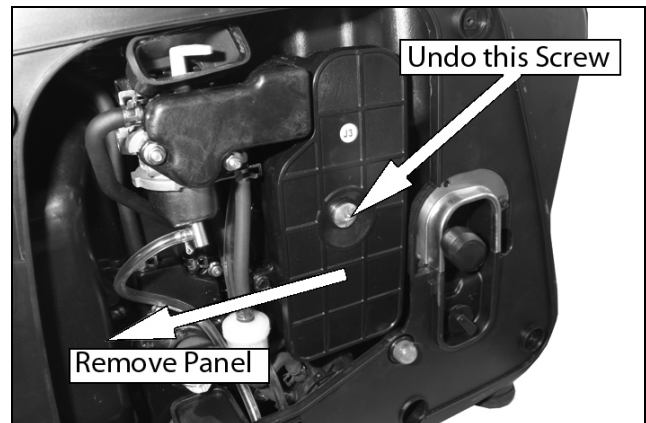

4. Remove the air filter element.
5. If the air filter is damaged contact the CLARKE spare parts department for a replacement.

- If the filter is dirty, wash it in a solution of warm water and mild detergent and then rinse thoroughly.
- Leave the filter to dry completely, once it is dry immerse the filter in clean engine oil and squeeze the filter to remove excess oil.

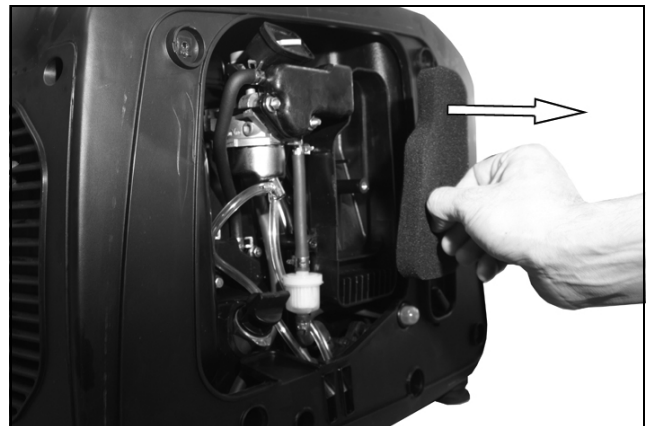

WARNING: DO NOT USE FLAMMABLE SOLVENTS OR PETROL TO CLEAN THE AIR FILTER.

6. Replace the filter into its original position and replace and secure the air filter cover.

SPARK PLUG (EVERY 50 HOURS OF USE)



CAUTION: ALLOW THE ENGINE TO COOL BEFORE REMOVING THE SPARK PLUG.

1. Remove the top maintenance panel.

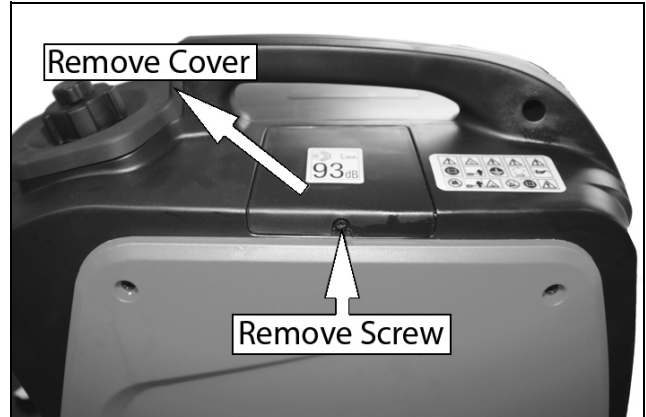

2. Remove the spark plug cap from the spark plug.

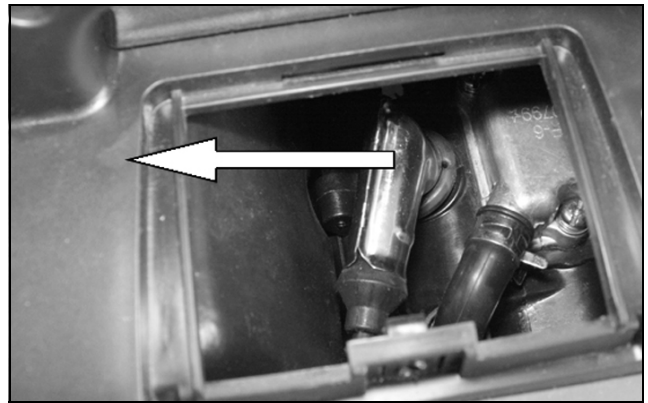

3. Fit the spark plug box spanner over the spark plug as shown.

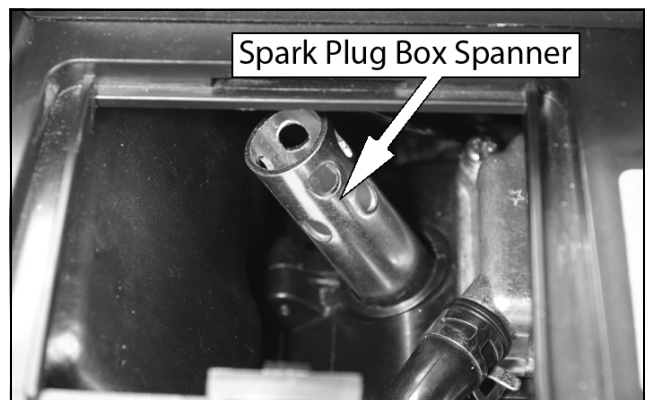

4. Remove the side panel and use the screwdriver supplied to turn the spark plug box spanner as shown.
5. When the spark plug has been removed, check for discoloration and use a wire brush to remove any carbon build up.



6. Check the spark plug gap (a) with a feeler gauge, it should be between 0.6 and 0.7 mm.
 - Adjust if necessary.
7. Check the overall condition of the spark plug and replace if damaged.

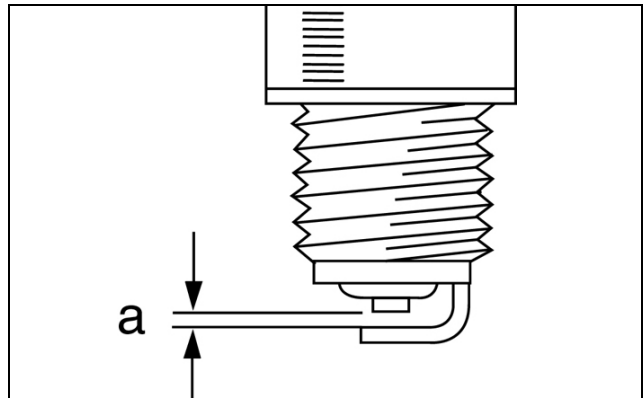

NOTE: Spark plugs are available from CLARKE Spare Parts department 020 8988 7400.

8. Reinstall the spark plug and replace the spark plug cap and top panel.

FUEL TANK FILTER (EVERY 100 HOURS OF USE OR EVERY 6 MONTHS)

Just inside the fuel tank is a fuel filter, check this filter periodically and remove any contaminants which may have accumulated.

1. Remove the fuel tank cap.
2. Lift out the filter inside.

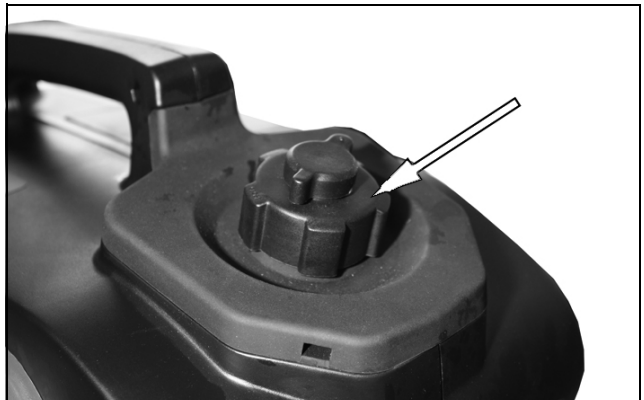

3. Clean the filter with solvent. If the filter is damaged, contact CLARKE Spare Parts department 020 8988 7400 for a replacement.
4. Replace the filter and fuel tank cap.

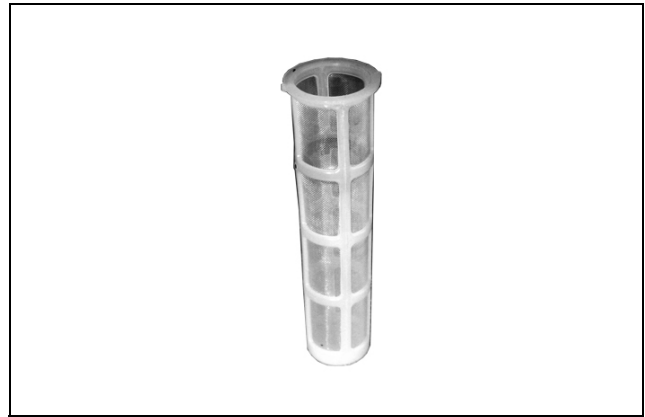

TROUBLESHOOTING

PROBLEM	CAUSE	SOLUTION
The generator fails to start	Engine switch is off.	Set the engine switch to 'on'.
	Not enough oil in the generator.	Add more oil, See page 11.
	No fuel	Add more fuel, See page 12.
	Spark plug not working correctly.	Change the spark plug, See page 21.
The generator fails to generate electricity	The device you are trying to power is faulty.	Make sure the device you want to power is working properly.
	The overload indicator is on.	Remove the appliance immediately, do not connect any appliance that requires more than 800W.
	(DC supply only) The DC Overload protector has activated.	Press the reset button. See page 17.
The generator is difficult to start	The air filter is dirty.	Clean the air filter. See page 20.

If this does not solve your problem, please contact the CLARKE service department. see below.

SPECIFICATIONS

Engine	Engine Model	SY152F-4
	Type	Petrol
	Displacement (cc)	99
	Ignition type	C.D.I
	Fuel tank capacity (L)	4.1
	Maximum run time at 3/4 load (h)	4.5
	Engine oil capacity (L)	0.52
	Guaranteed sound power (LWA dB)	93 dB
Generator	Rated Frequency (Hz)	50
	Rated AC Voltage (V)	230
	Rated Output Power: (Continuous) (W)	1700
	Maximum Rated Output Power (W)	1800
	Output Type	Modified Sine Wave
	Rated DC Voltage (V)	12
	Rated DC Current (A)	5
	Rated AC Output Current (A)	7.39
	Rated Power Factor	1
	Performance Class	G1
	Quality Class	A
	IP Rating	IP23M
Dimensions	Length (mm)	488
	Width (mm)	285
	Height (mm)	463
	Unpacked Weight (kg)	19.35

DECLARATION OF CONFORMITY - UKCA



Hemmill Street, Epping, Essex CM16 4LG

DECLARATION OF CONFORMITY

This is an important document and should be retained.

We hereby declare that this product(s) complies with the following statutory requirement(s):

- Electromagnetic Compatibility Regulations 2016
- Supply of Machinery (Safety) Regulations 2008
- Noise Emission in the Environment by Equipment for use Outdoors Regulations 2001
- The Non-Road Mobile Machinery (Type Approval and Emission of Gaseous and Particulate Pollutants) Regulations 2018
- The Restriction of the use of Certain Hazardous Substances in Electrical and Electronic Equipment Regulations 2012

The following standards have been applied to the product(s):

- EN 55012:2007+A1:2009, EN 61000-6-1:2007, EN/ISO 8528-13:2016, EN/ISO 3744:1995,
- EN 62321-1:2013, EN 62321-2:2014, EN 62321-3-1:2014, EN 62321-4:2014+A1:2017,
- EN 62321-5:2014, EN 62321-6:2015, EN 62321-7-1:2015, EN 62321-7-2:2017, EN 62321-8:2017

The technical documentation required to demonstrate that the product(s) meet(s) the requirement(s) of the aforementioned legislation has been compiled and is available for inspection by the relevant enforcement authorities.

The UKCA mark was first applied in: 2022

Signed:

J.A. Clarke
Director

IG2000D UKCA DDC 092322

Page 2 of 2



Hemmill Street, Epping, Essex CM16 4LG

DECLARATION OF CONFORMITY

This is an important document and should be retained.

Product Description: 1800W Inverter Generator

Model number(s): IG2000D

Serial / batch Number: N/A

Date of Issue: 23/09/2022

(Noise Conformity)

Notified Body: Intertek Testing & Certification Ltd

Davy Avenue,

Knowlhill,

Milton Keynes

MK5 8NL

UK

Technical Documentation Holder: A.R. Pond

Clarke International

2a Strubland Road

London E10 7RB

UK

Conformity Assessment Procedure: to 2000/14/EC Annex VI

Manufacturer: Clarke International

Noise Related Value: 1.7 kW

Measured Sound Power Level: 91 dB

Guaranteed Sound Power Level: 93 dB

IG2000D UKCA DDC 092322

Page 1 of 2

DECLARATION OF CONFORMITY - UKCA



Fitzwilliam Hall, Fitzwilliam Place, Dublin 2

DECLARATION OF CONFORMITY

This is an important document and should be retained.

We hereby declare that this product(s) complies with the following directive(s):

- 2014/30/EU Electromagnetic Compatibility Directive
- 2006/42/EC Machinery Directive
- 2000/14/EC Noise Emissions Directive (amended by 2005/88/EC)
- 2016/1828 Regulation (EU), Emission of Gaseous Particulates (with amendments).
- 2011/65/EU Restriction of the Use of Certain Hazardous Substances in Electrical and Electronic Equipment Directive

The following standards have been applied to the product(s):

- EN 55012:2007+A1:2009, EN 61000-6-1:2007, EN ISO 9528-13:2016, EN ISO 3744:1995,
- EN 62321-1:2013, EN 62321-2:2014, EN 62321-3-1:2014, EN 62321-4:2014+A1:2017,
- EN 62321-5:2014, EN 62321-6:2015, EN 62321-7-1:2015, EN 62321-7-2:2017, EN 62321-8:2017

The technical documentation required to demonstrate that the product(s) meet(s) the requirement(s) of the aforementioned directive(s) has been compiled and is available for inspection by the relevant enforcement authorities.

The CE mark was first applied in: 2021

Signed:

J.A. Clarke
Director

IG2000D CE Clarke DOC 092322

Page 2 of 2



Fitzwilliam Hall, Fitzwilliam Place, Dublin 2

DECLARATION OF CONFORMITY

This is an important document and should be retained.

Product Description:

1800W Inverter Generator

Model number(s):

IG2000D

Serial / batch Number:

N/A

Date of issue:

23/09/2022

(Noise Conformity)

Notified Body:

Intertek Testing & Certification Ltd

Davy Avenue,

Knowhill,

Milton Keynes

MK5 8NL

UK

Technical Documentation Holder:

A.R. Pond

Clarke International

2a Strubland Road

London E10 7RB

UK

Conformity Assessment Procedure: to 2000/14/EC Annex VI

Manufacturer:

Clarke International

Noise Related Value:

1.7 kW

Measured Sound Power Level:

91 dB

Guaranteed Sound Power Level:

93 dB

IG2000D CE Clarke DOC 092322

Page 1 of 2

A SELECTION FROM THE VAST RANGE OF

Clarke®

QUALITY PRODUCTS



AIR COMPRESSORS
From DIY to industrial, Plus air tools, spray guns and accessories.

GENERATORS
Prime duty or emergency standby for business, home and leisure.

POWER WASHERS
Hot and cold, electric and engine driven - we have what you need

WELDERS
Mig, Arc, Tig and Spot. From DIY to auto/industrial.

METALWORKING
Drills, grinders and saws for DIY and professional use.

WOODWORKING
Saws, sanders, lathes, mortisers and dust extraction.

HYDRAULICS
Cranes, body repair kits, transmission jacks for all types of workshop use.

WATER PUMPS
Submersible, electric and engine driven for DIY, agriculture and industry.

POWERTOOLS
Angle grinders, cordless drill sets, saws and sanders.

STARTERS/CHARGERS
All sizes for car and commercial use.



PARTS & SERVICE: 0208 988 7400

Parts Enquiries
Parts@clarkeinternational.com

Servicing & Technical Enquiries
Service@clarkeinternational.com

SALES: UK 01992 565333 or Export 00 44 (0)1992 565335

Clarke® INTERNATIONAL Hemnall Street, Epping, Essex CM16 4LG
www.clarkeinternational.com