

# Clarke®



## INTELLIGENT BATTERY CHARGER / MAINTAINER MODEL NO: IBC7 PART NO: 6267008

### OPERATION & MAINTENANCE INSTRUCTIONS



ORIGINAL INSTRUCTIONS

GC1020 - ISS 2

---

## INTRODUCTION

---

Thank you for purchasing this CLARKE Battery Charger.

Please read this manual thoroughly, before attempting to operate this product, and carefully follow all instructions given.

It is vitally important that ALL precautions are taken, as specified, which will not only provide protection for yourself and that of others around you, but will also ensure that the Battery Charger will give you long and satisfactory service.

---

## GUARANTEE

---

This CLARKE product is guaranteed against faulty manufacture for a period of 12 months from the date of purchase. Please keep your receipt as proof of purchase.

This guarantee is invalid if the product is found to have been abused or tampered with in any way, or not used for the purpose for which it was intended.

Faulty goods should be returned to their place of purchase, no product can be returned to us without prior permission.

This guarantee does not effect your statutory rights.

---

## ENVIRONMENTAL RECYCLING POLICY

---



Through purchase of this product, the customer is taking on the obligation to deal with the WEEE in accordance with the WEEE regulations in relation to the treatment, recycling & recovery and environmentally sound disposal of the WEEE.

In effect, this means that this product must not be disposed of with general household waste. It must be disposed of according to the laws governing Waste Electrical and Electronic Equipment (WEEE) at a recognised disposal facility.

---

# SAFETY PRECAUTIONS

---



**WARNING: ALWAYS SWITCH OFF THE CHARGER WHEN CONNECTING OR DISCONNECTING LEADS TO AVOID SPARKING AS HIGHLY INFLAMMABLE HYDROGEN GAS IS RELEASED IN THE PROCESS OF BATTERY CHARGING**

---

## PLEASE READ BEFORE USING THIS UNIT

1. Battery acid is highly corrosive. If spillage occurs, wipe off immediately and wash copiously with water. Particularly avoid contact with the eyes, but if this occurs, you must seek medical advice.
  2. Before charging ensure the battery terminals are clean and that the cells are filled with electrolyte to the correct level by adding distilled water where necessary.
  3. This product is not intended for use by persons with reduced physical, sensory or mental capabilities or lack of experience and knowledge.
  4. Children must not play with the charger.
  5. Do not expose this charger to rain.
  6. Never touch the negative and positive leads together.
  7. Never attempt any repairs yourself. If you have a problem with your charger contact your local Clarke dealer or contact [Service@Clarkeinternational.com](mailto:Service@Clarkeinternational.com)
  8. When charging is completed, ensure that the vehicle battery leads are secured to the proper terminals which should be clean, and lightly smeared with petroleum jelly to prevent corrosion. Finally, re-check the electrolyte level.
- 



**WARNING: CERTAIN TYPES OF SEALED OR MAINTENANCE-FREE BATTERIES NEED EXTRA CARE WHEN CHARGING. PLEASE CONSULT THE BATTERY MANUFACTURERS INSTRUCTIONS BEFORE USING THIS UNIT.**

---



**WARNING: SINCE TOXIC FUMES MAY BE RELEASED DURING BATTERY CHARGING, ONLY USE THIS UNIT IN A WELL VENTILATED AREA.**

---

# ELECTRICAL CONNECTIONS



**WARNING! READ THESE ELECTRICAL SAFETY INSTRUCTIONS THOROUGHLY BEFORE CONNECTING THE PRODUCT TO THE MAINS SUPPLY.**

Before switching the product on, make sure that the voltage of your electricity supply is the same as that indicated on the rating plate. This product is designed to operate on 230VAC 50Hz. Connecting it to any other power source may cause damage.

This product may be fitted with a non-rewireable plug. If it is necessary to change the fuse in the plug, the fuse cover must be refitted. If the fuse cover becomes lost or damaged, the plug must not be used until a suitable replacement is obtained.

If the plug has to be changed because it is not suitable for your socket, or due to damage, it should be cut off and a replacement fitted, following the wiring instructions shown below. The old plug must be disposed of safely, as insertion into a mains socket could cause an electrical hazard.



**WARNING! THE WIRES IN THE POWER CABLE OF THIS PRODUCT ARE COLOURED IN ACCORDANCE WITH THE FOLLOWING CODE:  
Blue = Neutral    Brown = Live**

If the colours of the wires in the power cable of this product do not correspond with the markings on the terminals of your plug, proceed as follows.

- The **Blue** wire must be connected to the terminal marked **N** or coloured **Black**.
- The **Brown** wire must be connected to the terminal marked **L** or coloured **Red**.

**Plug must be BS1363/A approved.**

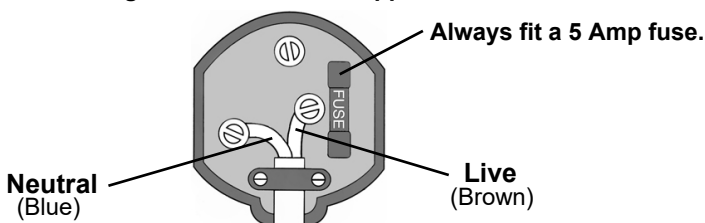

**Ensure that the outer sheath of the cable is firmly held by the clamp**

**We strongly recommend that this machine is connected to the mains supply via a Residual Current Device (RCD)**

If in any doubt, consult a qualified electrician. **DO NOT** attempt any repairs yourself.



**This symbol indicates that this is a Class II product, and does not require an earth connection.**

# OVERVIEW

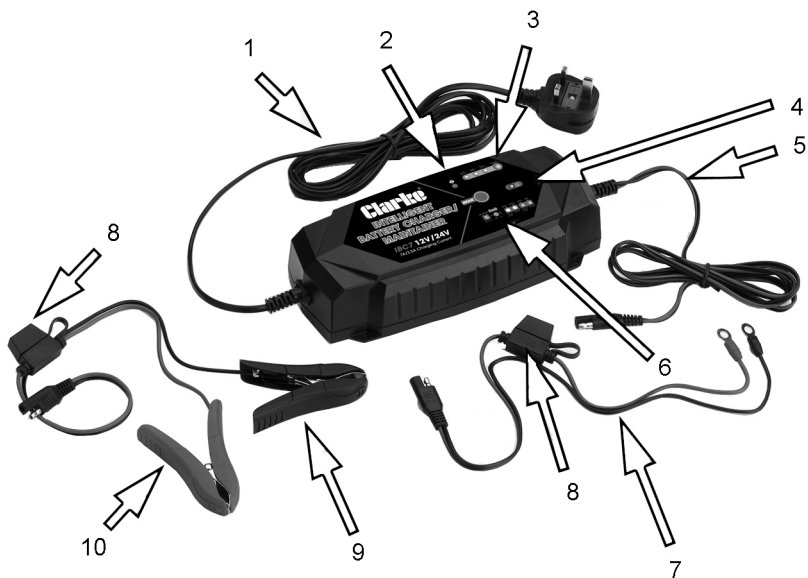

1	Mains power lead/plug	6	Charging Mode Indicator
2	Error LED	7	Output leads (eyelet connectors)
3	Charge Status LEDs 25-100%	8	Fuse Holder (15 Amp blade fuse)
4	Standby LED	9	Charging lead negative clamp
5	Output (charging) lead	10	Charging lead positive clamp

## CHARACTERISTICS

The IBC7 is designed for charging all types of 12V/24V lead-acid batteries including WET (flooded), GEL, MF (Maintenance Free), EFB (Enhanced flooded battery), and AGM (Absorbed Glass Mat) batteries. It is suitable for charging battery capacities from 14 to 200 Amp-Hours (12V) / 14 to 100 Amp-Hours (24V) and maintaining all battery sizes.

The in-built microprocessor provides fast and safe charging using its safety features to protect against sparking, reversed polarity, short circuit, overcurrent, overcharge and over heating.

The CHARGE indicator LED will be on during charging until completion. If the charger remains connected, it will automatically switch from full charging to Maintenance status to maintain the batteries during periods of storage.

## WALL MOUNTING

The IBC7 has four external holes for mounting. Mount the charger in the desired location with M3 self-tapping screws. Make sure there are no obstructions behind the mounting surface.

It is important to consider the distance of the charger mounting from the vehicle battery location. The DC cable length from the charger, with either the battery clamp or the eyelet terminal connectors is approximately 75 inches (1900 mm).

Alternatively the charger can be hung from a hook or peg by extending the loop shown.

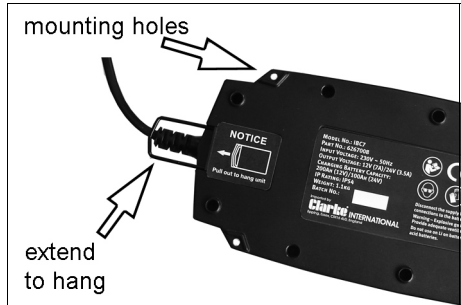

---

CAUTION: DO NOT HANG THE UNIT FROM THE POWER LEAD.



---

## PREPARATION

---

1. If necessary, remove the battery from a vehicle to charge it.
2. Always remove the grounded terminal from the battery first.
3. Ensure all accessories in the vehicle are switched off to prevent sparking.
4. Clean the battery terminals. Be careful to keep any corrosive matter from coming in contact with eyes.
5. Where possible, add distilled water to each cell until the battery acid reaches the level specified by the battery manufacturer. This helps remove unwanted gas from the cell. Do not overfill. For a battery without cell caps, follow the manufacturer's instructions.
6. Study all the battery manufacturer's specified precautions: for example, removing or not removing cell caps while being charged, and recommended rates of charge.
7. Refer to the vehicle manual to find the voltage of the battery and make sure that the output is set to the correct voltage.
8. If the charger has adjustable charge rate, charge the battery initially at the lowest rate.

## CHARGER LOCATION

1. Place the charger as far away from the battery as possible.
2. Do not position the charger above the battery during the charging procedure. Gases from the battery will corrode and damage the charger.
3. Do not let battery acid drip on the charger when reading a hydrometer for specific gravity or when you fill the battery.
4. Do not use the charger in an enclosed space with reduced airflow.

## CONNECTING TO A BATTERY

---



**WARNING: A SPARK NEAR THE BATTERY MAY CAUSE BATTERY EXPLOSION. TO REDUCE THE RISK OF A SPARK NEAR THE BATTERY:**

- Turn off the charger before you connect/disconnect the DC output clips.
  - Do not let the clamps touch each other.
  - Attach the clamps to the battery terminals and make sure that you get a good connection.
-

## WHEN THE BATTERY IS INSTALLED IN THE VEHICLE

1. Route the leads carefully to reduce the risk of damage by the bonnet, door, or engine parts.
2. Keep away from the fan blades, belts, pulleys, and other parts that can cause injury.
3. Check the polarity of the battery posts.
4. Refer to the vehicle manual to find out if the vehicle has a Negative or Positive earth.
  - For negative earth vehicles, connect the POSITIVE (RED) lead from the battery charger to the POSITIVE terminal on the battery. Connect the NEGATIVE (BLACK) lead to the vehicle chassis, engine block or suitable earthing point away from the battery. Do not connect the lead to the carburettor, (if fitted) fuel lines, or sheet metal body parts.
  - For positive earth vehicles, (very rare today) connect the NEGATIVE (BLACK) lead from the battery charger to the NEGATIVE terminal on the battery. Connect the POSITIVE (RED) lead to the vehicle chassis or engine block away from the battery. Do not connect the lead to the carburettor (if used) fuel lines, or sheet metal body parts.

**NOTE:** If the battery clamps are reversed, the ERROR LED will be on.

5. When charging is completed, switch off the charger and disconnect the plug from the power supply. Remove the lead from the vehicle chassis, and then remove the leads from the battery.

## WHEN THE BATTERY HAS BEEN REMOVED FROM THE VEHICLE

1. Make sure that you know the polarity of the battery posts.
2. Connect the POSITIVE (RED) lead to the POSITIVE post on the battery.
3. Reach over and connect the NEGATIVE (BLACK) lead at arms length to the NEGATIVE post on the battery.
4. When charging is completed, switch off the charger and disconnect the plug from the power supply. When you disconnect the charger from the battery always do it in the opposite order to the sequence of connection and break the first connection at arms length from the battery.

**NOTE:** A marine (boat) battery must be removed and charged on shore. To charge it on board requires equipment specially designed for marine use.



# THE CHARGING PROCESS

The IBC7 has a sophisticated computer system that performs a 7 - stage automatic charging cycle as follows:

## STEP 1: DIAGNOSIS

Checks that the battery has connected with the charger and also checks the battery voltage.

## STEP 2: DESULPHATION

If battery voltage is too low, this step automatically generates a pulsing current to remove sulphate.

## STEP 3: ANALYSE

Checks if the battery voltage reaches the threshold after desulphation and charging begins if the battery voltage is OK.

## STEP 4: SOFT START

Charges with constant current.

## STEP 5: BULK

Charges with constant maximum current until battery voltage has reached the threshold.

## STEP6: ABSORPTION

A gradually declining current charge for maximum battery voltage.

## STEP 7: ANALYSE

Testing if the battery can hold a charge

## STEP 8: MAINTENANCE

Continuously monitors the battery and charging current and will intelligently adapt to the variable battery voltage.

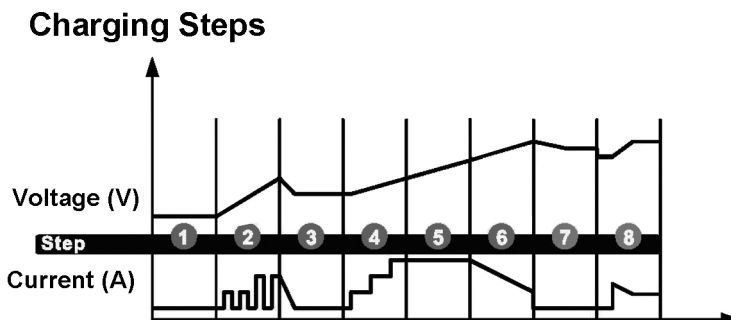

## CHARGING SETTINGS

The IBC7 has the following selectable charging settings:

MODE	EXPLANATION
STANDBY	In Standby mode, the charger is not charging or providing any power to the battery. Energy Save is activated during this mode, drawing microscopic power from the electrical outlet. When selected, a green LED will illuminate. NO POWER
12V NORM	For charging 12-volt Wet Cell, Gel Cell, Enhanced Flooded, Maintenance-Free and Calcium batteries. When selected, a green LED will illuminate.
12V COLD/ AGM	For charging 12-volt batteries in cold temperatures below 50°F (10°C) or AGM batteries. When selected a green LED will illuminate.
24V NORM	For charging 24-volt Wet Cell, Gel Cell, Enhanced Flooded, Maintenance-Free and Calcium batteries. When selected, a blue LED will illuminate.
24V COLD/ AGM	For charging 24-volt batteries in cold temperatures below 50°F (10°C) or AGM batteries. When selected a blue LED will illuminate.
12V/24V REPAIR	An advanced battery recovery mode for repairing idle, damaged, stratified or sulfated batteries. When selected a yellow LED and green (12V) or Blue (24V) LED will illuminate. (16.5V/1.5A)
13.6V SUPPLY	Converts to a DC power supply for powering any 12V DC device such as a tire inflator, oil changer or as a memory retainer when replacing a battery. When selected, a yellow LED will illuminate. (13.6V/5A)

## USING THE 12V/24V REPAIR MODE

12V/24V Repair is an advanced battery recovery mode for repairing idle, damaged, stratified or sulfated batteries. Not all batteries can be recovered.

Batteries tend to become damaged if kept at a low charge and/or never given the opportunity to receive a full charge. The most common battery problems are battery sulfation and stratification. Both battery sulfation and stratification will artificially raise the open circuit voltage of the battery, causing the battery to appear fully charged, while providing low capacity.

Use 12V/4V Repair in attempt to reverse these problems. For optimal results, take the battery through a full charge cycle, bringing the battery to full charge before using this mode.

12V/24V Repair can take up to eight hours to complete the recovery process and will return to Standby when completed.



CAUTION: USE THIS MODE WITH CARE. THIS MODE IS FOR 12/24 VOLT LEAD-ACID BATTERIES ONLY. THIS MODE USES A HIGH CHARGING VOLTAGE AND MAY CAUSE SOME WATER LOSS IN WET (FLOODED) CELL BATTERIES. BE ADVISED, SOME BATTERIES AND ELECTRONICS MAY BE SENSITIVE TO HIGH CHARGING VOLTAGES. TO MINIMIZE RISKS TO ELECTRONICS, DISCONNECT THE BATTERY BEFORE USING THIS MODE.

---

## USING THE 13.6V SUPPLY

The 13.6V Supply converts the charger to a constant current, constant voltage DC power supply. It can be used to power 12VDC devices, including; tire inflators, oil changers, coffee pots, seat heaters and more. As a power supply, it can also be used to retain a vehicle's on-board computer settings during battery repair or replacement. The 13.6V Supply provides 13.6-volts at 5A with overload protection at 6A (Max).



CAUTION: PRIOR TO USE, READ YOUR 12VDC DEVICE MANUAL TO DETERMINE IF IT IS SUITABLE FOR USE WITH THIS MODE. BOTH THE SPARK PROOF AND REVERSE POLARITY SAFETY FEATURES ARE DISABLED IN THIS MODE. DO NOT ALLOW THE POSITIVE AND NEGATIVE BATTERY CLAMP OR EYELET TERMINAL CONNECTORS TO TOUCH OR CONNECT TO EACH OTHER AS THE CHARGER COULD GENERATE SPARKS. CHECK THE POLARITY OF THE BATTERY TERMINALS BEFORE USING THIS MODE

---





# OPERATION

## TO START CHARGING THE BATTERY

1. Verify the voltage and chemistry of the battery.
2. Confirm that the battery clamps are correctly connected or eyelet connectors secure and that the power plug is plugged into a power outlet.
3. All LEDs will flash once after starting and will go into the last memory mode automatically after 10 seconds.
4. Press the mode button to toggle to the appropriate charge mode (press and hold for three seconds to enter an advanced charge mode) for the voltage and chemistry of your battery.
5. The mode LED will illuminate the selected charge mode and the Charge LEDs will illuminate (depending on the health of the battery) indicating the charging process has started.
6. When connected, the battery charger can stay in place, providing continuous charging.

## UNDERSTANDING THE CHARGE LEDs

The charger has four Charge LEDs - 25%, 50%, 75% and 100% which indicate the connected battery state of charge as shown below.

LED	EXPLANATION
25% 50% 75% 100% 	The 25% Charge LED (red) will flash when the battery is less than 25% charged. When the battery is 25% charged, the charge LED remains on.
25% 50% 75% 100% 	The 50% Charge LED (red) will flash when the battery is less than 50% charged. When the battery is 50% charged, the charge LED remains on.
25% 50% 75% 100% 	The 75% Charge LED (red) will flash when the battery is less than 75% charged. When the battery is 75% charged, the charge LED remains on.
25% 50% 75% 100% 	The 100% Charge LED (green) will flash when the battery is less than 100% charged. When the battery is 100% charged, the charge LEDs will switch off.

## UNDERSTANDING ADVANCED DIAGNOSTICS

When the ERROR LED warning is flashing it denotes a potential error condition. Only use the charger after correcting the error. If the cause is not apparent, consult a qualified person such as your Clarke dealer.

The following error warnings can occur.

1. Battery is not connected.
2. Battery voltage is too low.
3. Reverse polarity.
4. Overload.

## CHARGING TIME DURATION

Different battery capacity, residual voltage and charging current will all affect charging time.

The following table is for guidance in the case of a fully discharged battery.

- when discharging a 12V lead-acid battery to 9V, with 5A discharge current:
- when discharging a 24V lead acid battery to 18V with 10A discharge current.

BATTERY SIZE/ AH	APPROXIMATE TIME TO CHARGE IN HOURS (12V)		APPROXIMATE TIME TO CHARGE IN HOURS (24V)	
50	5H@14.5V	7H@14.7V	9H@29.3V	11H@30V
60	8H@14.4V	10H@14.7V	11H@29.3V	14H@30V
100	9H@14V	15H@14.5V	19H@29.3V	24H@30V
150	21H@14V	25H@14.8V	-----	-----
200	24H@14V	30H@14.7V	-----	-----

Switch off the charger and disconnect the mains plug from the power socket.

Remove the leads from the battery and store them safely with the charger.

After the full charging cycle, use the battery to start the vehicle's engine. If the engine does not start (excluding a defect with the vehicle its-self), it indicates this battery has declined any storage capacity and needs to be replaced.

---

## CARE & MAINTANENCE

---

This battery charger requires minimal maintenance. As with any appliance or tool, a few common sense rules will prolong its working life.

---



**WARNING: ALWAYS BE SURE THE CHARGER IS UNPLUGGED BEFORE PERFORMING ANY MAINTENANCE OR CLEANING. ANY REPAIRS MUST BE DONE BY A QUALIFIED SERVICE TECHNICIAN.**

---

1. Wind up the leads when not in use. Examine the leads at regular intervals for damage and have them replaced if necessary.
2. Clean the case and leads if necessary with a moist cloth and clean any corrosion from the clamps with a solution of water and baking soda.
3. Both the output cables (eyelet or crocodile clip) are fitted with a fuse as protection against short circuit when connecting to the battery.
4. Lift the cap and pull out the blown fuse.
  - Replacement 15 amp blade fuses are available from motor factors.

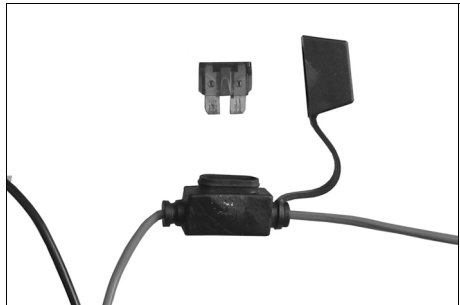

## TROUBLESHOOTING

Problem	Cause	Solution
ERROR light flashes	Battery not connected or open circuit	Connect battery correctly. If unsuccessful have the battery tested by a qualified technician.
	The battery voltage is too low to accept a charge.	
	The battery is wrongly connected (reverse polarity)	
	Overload	
Battery does not charge	Lack of AC input power.	Make sure that the charger is plugged into AC outlet and the POWER LED is lit.
	Faulty connections to battery terminals.	Unplug the charger and check the battery connection; ensure that there is a good connection at the battery terminal/post and/or vehicle chassis.
	Wrong charge voltage selection.	Check that the correct charge voltage was selected for the battery being charged.
	Battery voltage too low.	Ensure enough charging time was allowed to charge battery.
	Charging a very cold battery.	If the battery being charged is extremely cold, it will not accept a high rate of charge, so the initial charge rate will be slow. The rate of charger will increase as the battery warms up. Never attempt to charge a frozen battery.

# COMPONENT PARTS

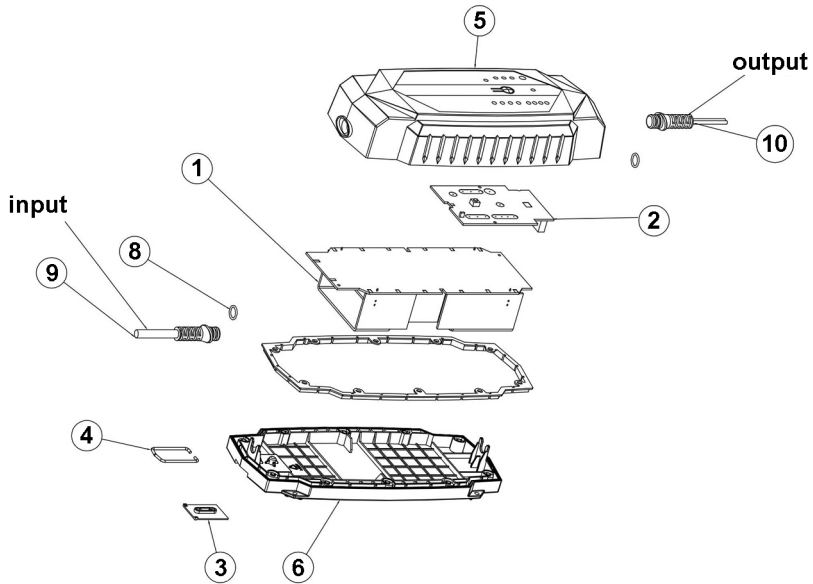

No	DESCRIPTION
1	PCB-A
2	PCB-B
3	CT7000 clamp
4	CT7000 steel hanging hook
5	CT7000 top shell
6	CT7000 bottom shell
7	CT7000 Sealing ring
8	O-ring
9	Input cable
10	Outlet cable



---

## SPECIFICATIONS

---

Model Number	IBC7
Input voltage / Current	220-240V, 50Hz, 1A
Battery charging voltages:	12V and 24V
Power	Max 120W
Output current	7A (12V), 3.5A (24V)
Charging steps	8 steps, (smart charger)
Charging Battery Capacity	14-200 Ah (12V), 14-100 Ah (24V)
IP Rating	IP54
Operating Temperature Range	-10 to 40°C
Dimensions (D x W x H)	300 x 106 x 61 mm
Supply cable length	2900 mm
Charging lead length (Black and Red)	1900 mm
Weight	1.09 kg

# DECLARATION OF CONFORMITY



**Clarke**<sup>®</sup>  
**INTERNATIONAL**

Hemnal Street, Epping, Essex CM16 4LG

## DECLARATION OF CONFORMITY

This is an important document and should be retained.

We hereby declare that this product(s) complies with the following directive(s):

2014/30/EU      *Electromagnetic Compatibility Directive.*  
2014/35/EU      *Low Voltage Equipment Directive.*  
2011/65/EU      *Restriction of Hazardous substances.*

The following standards have been applied to the product(s):

*EN 55014-1:2006 +A1:2009 +A2:2011, EN 55014-2:2015, EN 62233:2008,  
EN 61000-3-2:2014, EN 61000-3-3:2013, EN 60335-2-29:2004+A2:2010,  
EN 60335-1:2012 +A11:2014.*

The technical documentation required to demonstrate that the product(s) meet(s) the requirement(s) of the aforementioned directive(s) has been compiled and is available for inspection by the relevant enforcement authorities.

The CE mark was first applied in: 2018

**Product Description:**      Intelligent Battery Charger 12v / 24v  
**Model number(s):**          IBC7  
**Serial / batch Number:**      N/A  
**Date of Issue:**              30/05/2018

Signed:

J.A. Clarke  
Director



# A SELECTION FROM THE VAST RANGE OF

# Clarke®

## QUALITY PRODUCTS



### AIR COMPRESSORS

From DIY to industrial, Plus air tools, spray guns and accessories.

### GENERATORS

Prime duty or emergency standby for business, home and leisure.

### POWER WASHERS

Hot and cold, electric and engine driven - we have what you need

### WELDERS

Mig, Arc, Tig and Spot. From DIY to auto/industrial.

### METALWORKING

Drills, grinders and saws for DIY and professional use.

### WOODWORKING

Saws, sanders, lathes, mortisers and dust extraction.

### HYDRAULICS

Cranes, body repair kits, transmission jacks for all types of workshop use.

### WATER PUMPS

Submersible, electric and engine driven for DIY, agriculture and industry.

### POWER TOOLS

Angle grinders, cordless drill sets, saws and sanders.

### STARTERS/CHARGERS

All sizes for car and commercial use.

## PARTS & SERVICE:

## 0208 988 7400

### Parts Enquiries

[Parts@clarkeinternational.com](mailto:Parts@clarkeinternational.com)

### Servicing & Technical Enquiries

[Service@clarkeinternational.com](mailto:Service@clarkeinternational.com)

SALES: UK 01992 565333 or Export 00 44 (0)1992 565335

**Clarke** INTERNATIONAL Hemnall Street, Epping, Essex CM16 4LG  
[www.clarkeinternational.com](http://www.clarkeinternational.com)