

Clarke®



INTELLIGENT BATTERY CHARGER/MAINTAINER

MODEL NO: IBC40

PART NO: 6267014

OPERATION & MAINTENANCE INSTRUCTIONS



ORIGINAL INSTRUCTIONS

DL0722 - ISS 3

INTRODUCTION

Thank you for purchasing this CLARKE Battery Charger / Maintainer.

Before use, read this manual thoroughly and follow all instructions given.

1. The IBC40 is designed for charging all types of 12V lead-acid and 24V lead-acid batteries, including WET (Flooded), MF (Maintenance-Free), EFB (Enhanced Flooded Battery), GEL, AGM (Absorbed Glass Mat) batteries.
2. A built-in intelligent microprocessor makes charging faster, easier and safer.
3. This charger has safety features, including protection for reverse polarity, short circuit, overheat and overcharge.

GUARANTEE

This CLARKE product is guaranteed against faulty manufacture for a period of 12 months from the date of purchase. Please keep your receipt as proof of purchase.

This guarantee is invalid if the product is found to have been abused or tampered with in any way, or not used for the purpose for which it was intended.

Faulty goods should be returned to their place of purchase, no product can be returned to us without prior permission.

This guarantee does not effect your statutory rights.

ENVIRONMENTAL RECYCLING POLICY



Through purchase of this product, the customer is taking on the obligation to deal with the WEEE in accordance with the WEEE regulations in relation to the treatment, recycling & recovery and environmentally sound disposal of the WEEE.

In effect, this means that this product must not be disposed of with general household waste. It must be disposed of according to the laws governing Waste Electrical and Electronic Equipment (WEEE) at a recognised disposal facility.

SAFETY INSTRUCTIONS



WARNING: WEAR EYE PROTECTION, HAND AND CLOTHING PROTECTION. AVOID TOUCHING EYES WHILE WORKING WITH A BATTERY. SEE YOUR LOCAL CLARKE DEALER FOR ALL YOUR PPE REQUIREMENTS.

SAFETY PRECAUTIONS FOR WORKING IN THE VICINITY OF A BATTERY

1. If battery electrolyte contacts skin or clothing, wash immediately with soap and water. If electrolyte enters your eye, immediately flood the eye with running clean cold water for at least 15 minutes and get medical attention immediately.
2. Clean the battery terminals before they are connected to the charger. Be careful to keep corrosion from coming into contact with your eyes.
3. Batteries generate explosive gases during normal operation. Use in a well-ventilated area.
4. Consider having someone close enough or within the range of your voice to come to your aid when you work near a battery.
5. DO NOT smoke, strike a match, or cause a spark in vicinity of a battery or engine. Avoid explosive gas, flames and sparks.
6. Remove all rings, bracelets, necklaces, and watches while working with a vehicle battery. These items may produce a short-circuit that could cause severe burns.
7. Be extra cautious to reduce risk of dropping a metal tool onto the battery. It might spark or short-circuit a battery or other electrical hardware which may cause an explosion or fire.
8. Study all battery manufacturer's specific precautions such as removing or not removing cell caps while charging and recommended rates of charge.
9. When it is necessary to remove a battery from a vehicle to charge it, always remove the grounded terminal from the battery first. Make sure all accessories in the vehicle are off.
10. It is NOT intended to supply power to an extra-low-voltage electrical system or to charge dry-cell batteries. Charging dry-cell batteries may burst and cause injury to persons and property.
11. NEVER charge a frozen, damaged, leaking or non-rechargeable battery.
12. DO NOT let battery acid drip on the charger when reading a hydrometer for specific gravity or when you fill the battery.

SAFETY PRECAUTIONS FOR USING THE CHARGER





WARNING: ALWAYS SWITCH OFF THE CHARGER WHEN CONNECTING OR DISCONNECTING LEADS.

1. NEVER place the charger in the engine compartment or near moving parts or near the battery; place as far away from them as the clamp leads allow.
2. DO NOT cover the charger while charging.
3. DO NOT expose to rain or wet conditions.
4. Use of an attachment not recommended or sold by the manufacturer may result in a risk of fire, electric shock or injury to persons.
5. DO NOT overcharge batteries by selecting the wrong charge mode.
6. To reduce the risk of damage to the electric plug and lead, pull by the plug rather than the lead when disconnecting the charger.
7. Operate with caution if the charger has received a impact/blow or been dropped. Have it checked and repaired if damaged.
8. Any repair must be carried out by the manufacturer or an authorized CLARKE repair agent in order to avoid danger.

CHARGER LOCATION

1. Place the charger as far away from the battery as possible.
2. DO NOT position the charger above the battery during the charging procedure. Gases from the battery will corrode and damage the charger.
3. DO NOT use the charger in an enclosed space with reduced airflow.

SAFETY SYMBOLS

	Wear eye protection		Wear protective clothing
	Wear protective gloves		

ELECTRICAL CONNECTIONS



WARNING! READ THESE ELECTRICAL SAFETY INSTRUCTIONS THOROUGHLY BEFORE CONNECTING THE PRODUCT TO THE MAINS SUPPLY.

Before switching the product on, make sure that the voltage of your electricity supply is the same as that indicated on the rating plate. This product is designed to operate on 230VAC 50Hz. Connecting it to any other power source may cause damage.

This product may be fitted with a non-rewireable plug. If it is necessary to change the fuse in the plug, the fuse cover must be refitted. If the fuse cover becomes lost or damaged, the plug must not be used until a suitable replacement is obtained.

If the plug has to be changed because it is not suitable for your socket, or due to damage, it should be cut off and a replacement fitted, following the wiring instructions shown below. The old plug must be disposed of safely, as insertion into a mains socket could cause an electrical hazard.

If the colours of the wires in the power cable of this product do not correspond with the markings on the terminals of your plug, proceed as follows.

- The **Blue** wire must be connected to the terminal marked **N** or coloured **Black**.
- The **Brown** wire must be connected to the terminal marked **L** or coloured **Red**.

Plug must be BS1363/A approved.

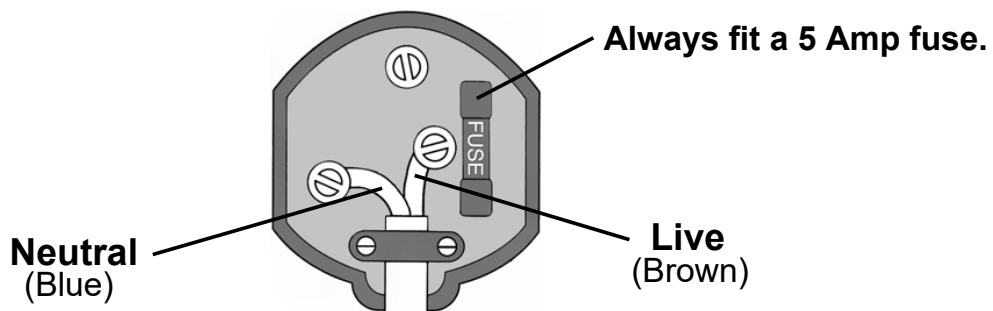

Ensure that the outer sheath of the cable is firmly held by the clamp

We strongly recommend that this machine is connected to the mains supply via a Residual Current Device (RCD). If in any doubt, consult a qualified electrician. **DO NOT** attempt any repairs yourself.



This symbol indicates that this is a Class II product, and does not require an earth connection.

THE CHARGING PROCESS

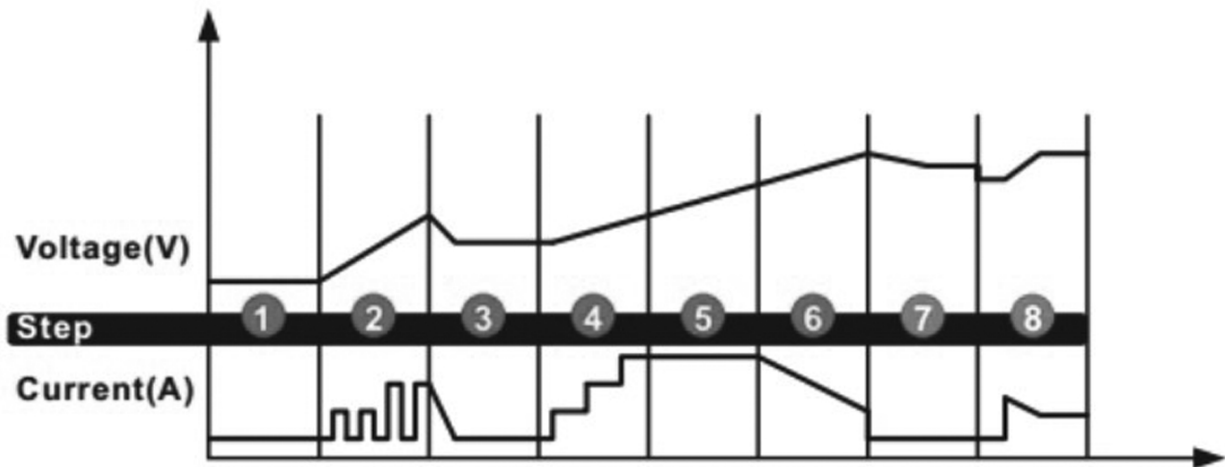

STEP 1: DIAGNOSIS

Check if the battery has connected with the charger and also check the battery voltage.

STEP 2: DESULPHATION

If battery voltage is too low, the program automatically generates a pulsing current to remove sulphate.

STEP 3: ANALYSE

Check if the battery voltage reaches to the minimum threshold after desulphation, and charging begins if the battery voltage is OK.

STEP 4: SOFT START

Charge with stepped constant current.

STEP 5: BULK

Charge with constant maximum current until the battery voltage has reached the threshold.

STEP 6: ABSORPTION

Provide gradually declining current charge for maximum battery voltage.

STEP 7: ANALYSE

Test if the battery can hold charge

STEP 8: MAINTENANCE

Continuously monitor the battery, and charging current will intelligently adapt to the variable battery voltage. (pulse form protection).

OVERVIEW

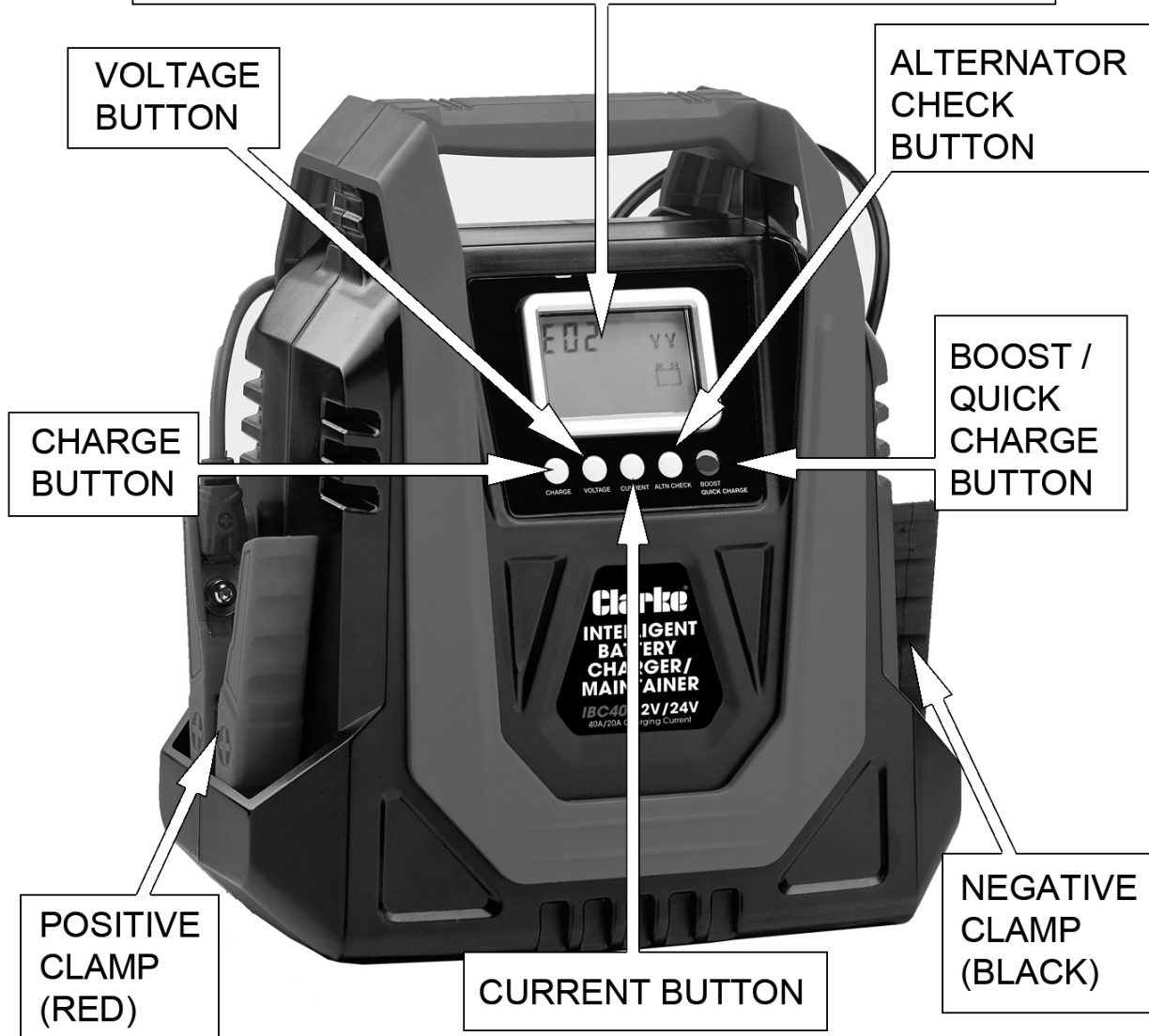
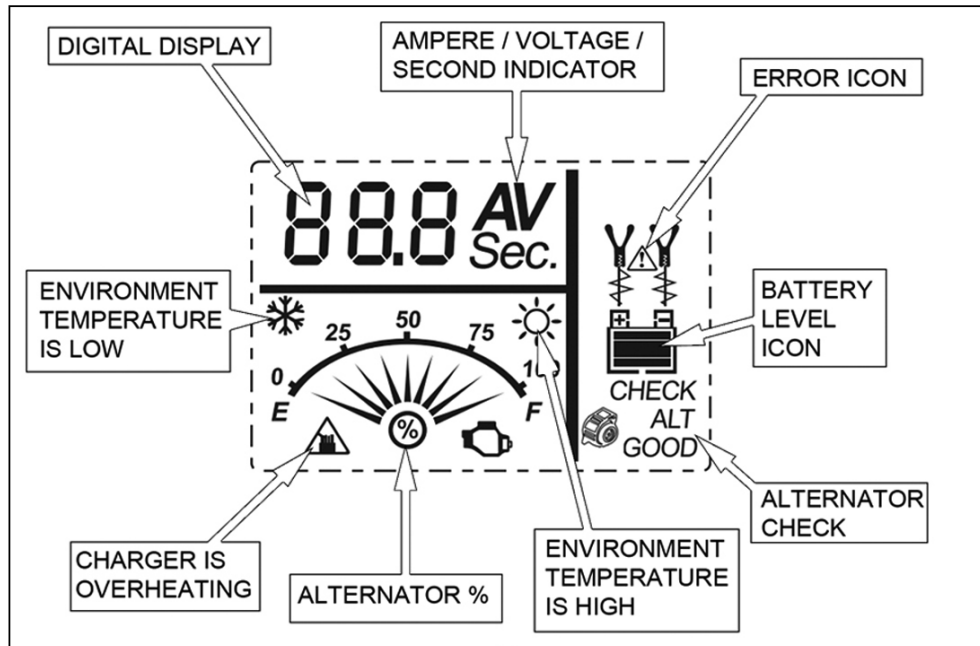

CONNECTING TO THE BATTERY



CAUTION: A MARINE (BOAT) BATTERY MUST BE REMOVED AND CHARGED ON SHORE. TO CHARGE IT ON BOARD REQUIRES EQUIPMENT SPECIALLY DESIGNED FOR MARINE USE.

1. Identify the polarity of battery posts. The positive battery terminal is typically marked by these letters or symbol (POS,P,+). The negative battery terminal is typically marked by these letters or symbol (NEG,N,-).
2. DO NOT make any connections to the carburetor, fuel lines, or thin metal parts.
3. Identify if you have a negative or positive grounded vehicle. This can be done by identifying which battery post (NEG or POS) is connected to the chassis.
 - **FOR A NEGATIVE GROUNDED VEHICLE (MOST COMMON):** connect the RED POSITIVE clamp first to the positive battery terminal, then connect the BLACK NEGATIVE clamp to the negative battery terminal or vehicle chassis.
 - **FOR A POSITIVE GROUNDED VEHICLE (VERY UNCOMMON):** connect the BLACK NEGATIVE clamp first to the negative battery terminal, then connect the RED POSITIVE clamp to the positive battery terminal or vehicle chassis.
4. When disconnecting, disconnect in the reverse sequence, removing the negative first (or positive first for positive ground systems).

CHARGING MODESS

SELECT MODE	FOR BATTERY SIZE (AH)
12V 5A	10 - 150Ah
12V 10A	40 - 300Ah
12V 20A	60 - 500Ah
12V 40A	120 - 500Ah
24V 5A	10 - 150Ah
24V 10A	40 - 300Ah
24V 20A	60 - 220Ah
12V 40A BOOST	Any Capacity
12V ALTERNATOR CHECK	Any Capacity



OPERATION

1. Connect the battery as described on page 8.
2. Plug in the mains plug and switch it on.
3. The charger will automatically detect the battery voltage (12V or 24V).
4. After 10 seconds the charger will begin charging the battery using the following mode 12V/5A or 24V/5A.
 - The user can manually select charging voltage / current modes by pressing the "VOLTAGE" or "CURRENT" button within the first 10 seconds after switching on (a countdown is shown on the LCD).

NOTE: If you choose 24V Mode(s) for 12V battery, the 12V battery will be damaged

- Once the battery type has been selected successfully and charging is started, you must disconnect the AC plug and plug in again if you want to change the battery type mode of the charger.
 - During charging, the display will show voltage (12V or 24V) and charging current alternately.
 - When the "VOLTAGE" button is pressed, the display shows battery voltage (e.g. 12.1 V) .
5. During charging, pressing the "CHARGE" button will cause the charger to turn off.
 - The charger will be restarted by pressing "CHARGE" button again.
 6. Battery level is indicated by the "battery level icon". When the battery is fully charged, the charger will automatically switch from full charge to maintenance status without overcharging or damaging the battery.

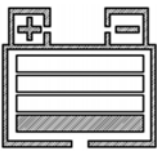
BATTERY LEVEL INDICATOR

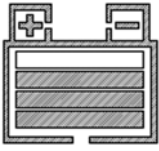
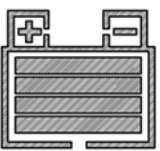
LEVEL ICON	EXPLANATION	LEVEL ICON	EXPLANATION
	The 25% bar will slowly flash when the battery level is less than 25%. When 25% is reached, the bar will be solid.		The 50% bar will slowly flash when the battery level is less than 50%. When 50% is reached, the bar will be solid.
	The 75% bar will slowly flash when the battery level is less than 75%. When 75% is reached, the bar will be solid.		The 100% bar will slowly flash when the battery level is less than 100%. When 100% is reached, the bar will be solid. Meanwhile the maintenance charging is activated.

ADVANCED CHARGING MODES

The following modes are advanced charging modes that require your full attention before selecting.

USING 12V BOOST



WARNING: DO NOT USE BOOST MORE THAN TWO TIMES IN A 24-HOUR PERIOD. IF TWO BOOSTS CANNOT SUCCESSFULLY START YOUR VEHICLE, HAVE YOUR BATTERY REPLACED OR EVALUATED BY A LOCAL BATTERY STORE.

1. Connect the charger to the battery as shown on page 7 and switch on at the mains power supply.
2. Allow the charger to start charging after an initial 10 second wait.
3. Press the BOOST/QUICK CHARGE button to start the boost charge mode
 - For optimum results, allow boost to complete its 5-minute charge cycle.
 - After 5 minutes the display will show "000", and you are ready to start your vehicle.
 - After each boost, the charger has a mandatory 5-minute rest for safety reasons (even if you press the BOOST/QUICK CHARGE button again, the charger will not work).
 - After cooling, the LCD shows "End"
4. Press any button to enter the normal charging mode, or the charger will automatically enter the normal charging mode after 10 minutes.
5. If unsuccessful when starting your vehicle, let the battery rest for 15 minutes and try boost again. Most vehicles will start with one boost.
6. Using 12V ALTERNATOR CHECK

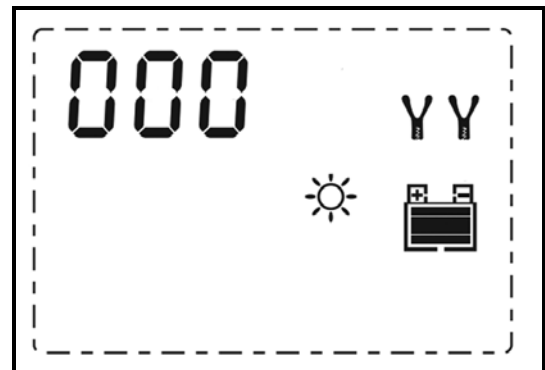

ALTERNATOR % (12V ONLY) -

1. Connect the charger to the battery as shown on page 7 and switch on at the mains power supply



NOTE: The battery must be installed in the vehicle.

2. Press and hold the ALTN CHECK button for 3 seconds.

- The  icon will appear.

3. Start the vehicle and turn on the vehicle's headlights.

- The digital display shows an estimated output percentage of the vehicle's charging system.

READING	OUTPUT IS:	ICON
0% to 100%	GOOD	
Below 0% (13.2 volts)	LOW	 Flashes Slowly
Above 100% (14.6 volts)	HIGH	 Flashes Quickly

- If you get a LOW or HIGH reading, have the electrical system checked by a qualified technician. After 10 seconds, the charger will return to the normal charging process.

CARE & MAINTENANCE









This battery charger requires minimal maintenance. As with any appliance or tool, a few common sense rules will prolong its working life.



WARNING: ALWAYS BE SURE THE CHARGER IS UNPLUGGED BEFORE PERFORMING ANY MAINTENANCE OR CLEANING. ANY REPAIRS MUST BE DONE BY A QUALIFIED CLARKE SERVICE TECHNICIAN.

1. Wind up the leads when not in use. Examine the leads at regular intervals for damage and have them replaced if necessary.
 - Clean the case and leads if necessary with a moist cloth and clean any corrosion from the clamps with a solution of water and baking soda.

TROUBLESHOOTING

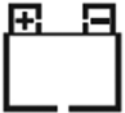
DISPLAY	CAUSE	SOLUTION
E01 (with buzzer) 	The charger is overheating	The charging will automatically pause with the alarm sound. Do NOT cut off the power supply and the charger will work again when cooled down.
E02  	1) Open-circuit	1) Connect the red and black clamps to the battery posts
	2) Dirty Battery Posts	2) Clean the battery posts
	3) Dead Battery	3) Replace the battery with a new one immediately
	4) Output Short Circuit	4) Disconnect red and black output terminals
E03  	Charging in 12V Mode(s) for 24V battery	An alarm sound will remind you. Please restart the charger and choose the correct charge mode. CAUTION: If you choose 24V Mode(s) for 12V battery, the 12V battery will be damaged!
E04  	Battery cannot store electric charge during charging process	Replace the battery with a new one immediately
E05  	Battery is heavily corroded and cannot be recovered through desulphation process	Replace the battery with a new one immediately

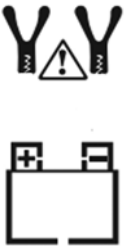
DISPLAY	CAUSE	SOLUTION
E06 	Reverse Polarity	Swap the position of the charging leads.
Battery does not charge	Lack of AC input power.	Make sure that the charger is plugged into the AC outlet and the POWER LED is lit.
Very slow charging	Charging a very cold battery.	If the battery being charged is extremely cold, it will not accept a high rate of charge, so the initial charge rate will be slow. The rate of charge will increase as the battery warms up. Never attempt to charge a frozen battery.

SPECIFICATIONS

Model Number	IBC40
Input Voltage	230V AC, ~ 50 - 60Hz,
Battery charging voltages:	12V & 24V DC
Output current	12VDC, 5A/10A/20A/40A
	24VDC, 5A/10A/20A
	12VDC, 40A, 300s (Boost)
Efficiency	85% approx
IP Rating	IP20
Battery Capacity	10-500 Ah (12V), 10-300 Ah (24V)
Charging steps	8 steps (smart charger)
Operating Temperature Range	-10 to 50°C
Dimensions (D x W x H)	187 x 285 x 320 mm
Weight	3.6 kg
Charging lead length (red& black)	1.85 m
Mains power cable length	1.2 m

COMPONENT PARTS

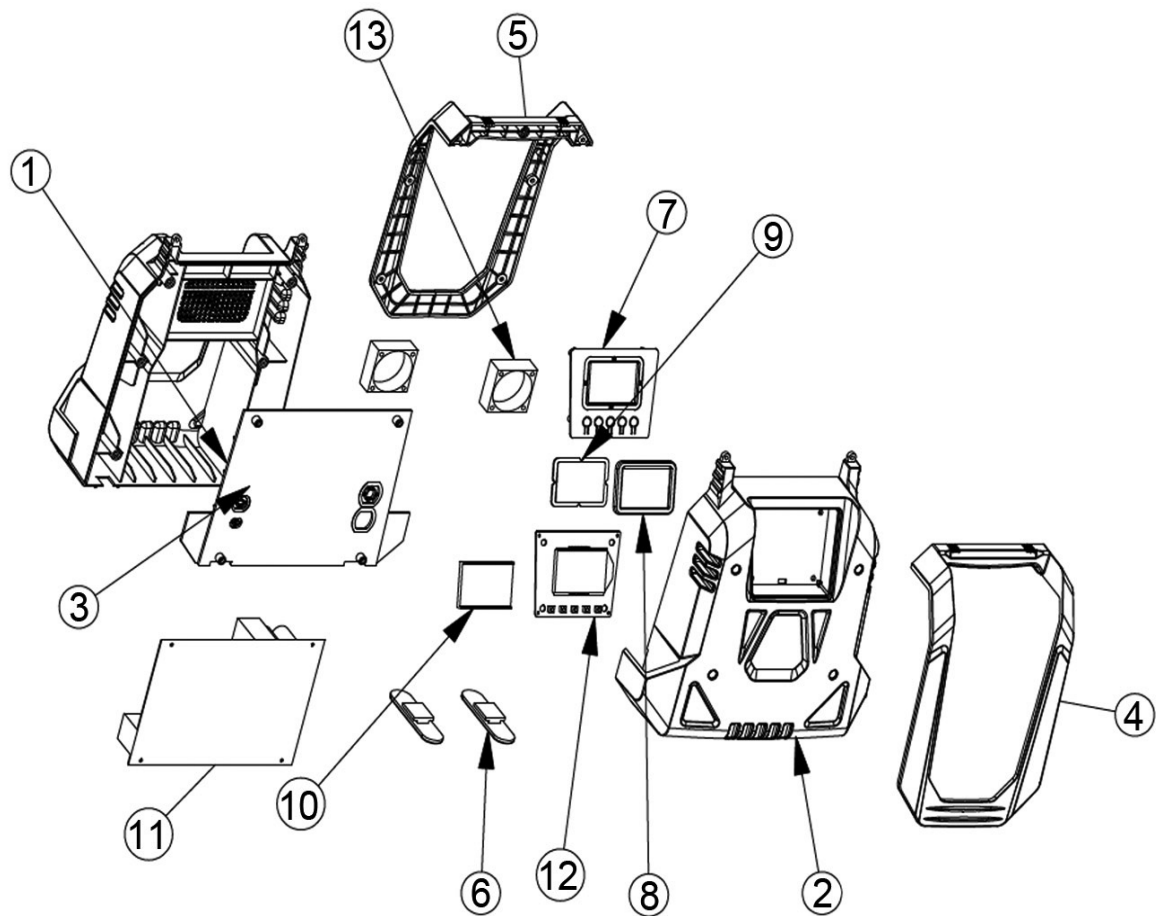

No	Part Name	QTY	Part Number
1	Back Shell	1	GTIBC4001
2	Front Shell	1	GTIBC4002
3	Middle Shell	1	GTIBC4003
4	Front Handle	1	GTIBC4004
5	Back Handle	1	GTIBC4005
6	Rubber Feet	2	GTIBC4006
7	Display Panel	1	GTIBC4007
8	LCD Surround	1	GTIBC4008
9	Transparent Screen	1	GTIBC4009
10	LCD Support	1	GTIBC4010
11	PCB A	1	GTIBC4011
12	PCB B	1	GTIBC4012
13	5020 Fan	2	GTIBC4013

DECLARATION OF CONFORMITY



Hemmill Street, Epping, Essex CM16 4UG

DECLARATION OF CONFORMITY

This is an important document and should be retained.

We hereby declare that this product(s) complies with the following statutory requirement(s):

Electromagnetic Compatibility Regulations 2016
Electrical Equipment (Safety) Regulations 2016
The Restriction of the Use of Certain Hazardous Substances in Electrical and Electronic Equipment Regulations 2012

The following standards have been applied to the product(s):

EN 61000-6-1:2007, EN 61000-6-3:2007+A1:2011, EN 60335-2-29:2004/A2:2010,
EN 60335-1:2012/A1:2014/A13:2017, EN 62233:2008, IEC 62321-1:2013, IEC 62321-2:2013,
IEC 62321-3-1:2013, IEC 62321-4:2013+A1:2017, IEC 62321-5:2013, IEC 62321-6:2015,
IEC 62321-7-1:2015, IEC 62321-7-2:2017, IEC 62321-8:2017, ISO 17075-1:2017.

The technical documentation required to demonstrate that the product(s) meet(s) the requirement(s) of the aforementioned legislation has been compiled and is available for inspection by the relevant enforcement authorities.

The UKCA mark was first applied in: 2022

Product Description: Intelligent Battery Charger 40A, 12/24V
Model number(s): IBC40
Serial / batch Number: N/A
Date of Issue: 01/07/2022

Signed:

J.A. Clarke
Director



Fitzwilliam Hall, Fitzwilliam Place, Dublin 2

DECLARATION OF CONFORMITY

This is an important document and should be retained.

We hereby declare that this product(s) complies with the following directive(s):

2014/30/EU Electromagnetic Compatibility Directive
2014/35/EU Low Voltage Equipment Directive
2011/65/EU Restriction of the Use of Certain Hazardous Substances in Electrical and Electronic Equipment Directive

The following standards have been applied to the product(s):

EN 61000-6-1:2007, EN 61000-6-3:2007+A1:2011, EN 60335-2-29:2004/A2:2010,
EN 60335-1:2012/A1:2014/A13:2017, EN 62233:2008, IEC 62321-1:2013, IEC 62321-2:2013,
IEC 62321-3-1:2013, IEC 62321-4:2013+A1:2017, IEC 62321-5:2013, IEC 62321-6:2015,
IEC 62321-7-1:2015, IEC 62321-7-2:2017, IEC 62321-8:2017, ISO 17075-1:2017.

The technical documentation required to demonstrate that the product(s) meet(s) the requirement(s) of the aforementioned directive(s) has been compiled and is available for inspection by the relevant enforcement authorities.

The CE mark was first applied in: 2019

Product Description: Intelligent Battery Charger 40A, 12/24V
Model number(s): IBC40
Serial / batch Number: N/A
Date of Issue: 01/07/2022

Signed:

J.A. Clarke
Director

A SELECTION FROM THE VAST RANGE OF

Clarke®

QUALITY PRODUCTS



AIR COMPRESSORS
From DIY to industrial, Plus air tools, spray guns and accessories.

GENERATORS
Prime duty or emergency standby for business, home and leisure.

POWER WASHERS
Hot and cold, electric and engine driven - we have what you need

WELDERS

Mig, Arc, Tig and Spot.
From DIY to auto/industrial.

METALWORKING
Drills, grinders and saws for DIY and professional use.

WOODWORKING
Saws, sanders, lathes, mortisers and dust extraction.

HYDRAULICS
Cranes, body repair kits, transmission jacks for all types of workshop use.

WATER PUMPS
Submersible, electric and engine driven for DIY, agriculture and industry.

POWERTOOLS
Angle grinders, cordless drill sets, saws and sanders.

STARTERS/CHARGERS
All sizes for car and commercial use.



PARTS & SERVICE: 0208 988 7400

Parts Enquiries
Parts@clarkeinternational.com

Servicing & Technical Enquiries
Service@clarkeinternational.com

SALES: UK 01992 565333 or Export 00 44 (0)1992 565335

Clarke INTERNATIONAL Hemnall Street, Epping, Essex CM16 4LG
www.clarkeinternational.com